

HOW TO BECOME AN AMATEUR OPERATOR

JUNE 27

15c

1925,

RADIO WORLD

Title Reg. U.S. Pat. Off

Vol. 7. No. 14. *ILLUSTRATED* Every Week

**REVERSE FEEDBACK
BY CAPACITY METHOD
GETS SCOTLAND ON
A 2-TUBE CIRCUIT**

5-TUBE POWER HOUSE

POCKETBOOK PORTABLE, USING FOUR TUBES

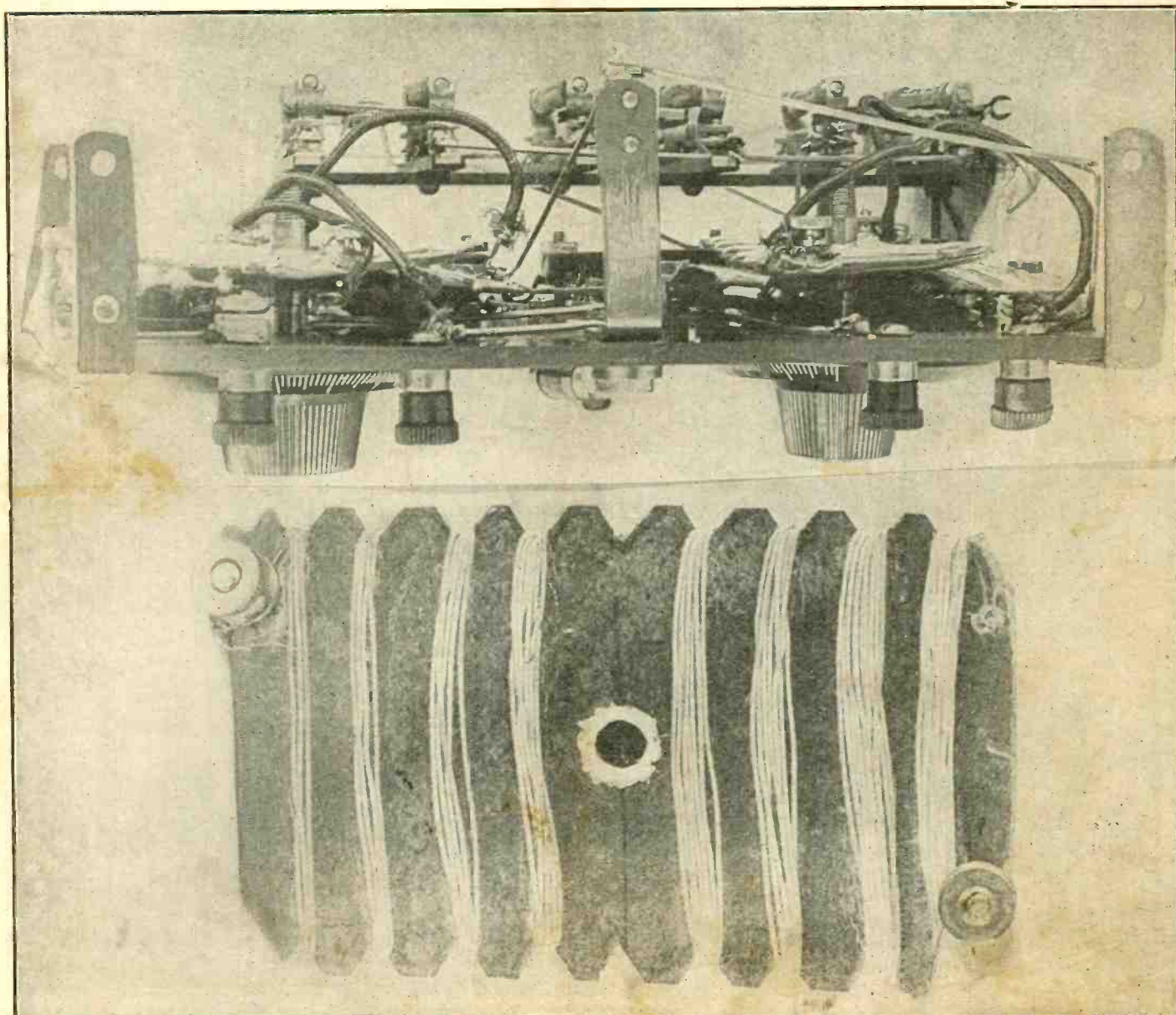

THE POCKETBOOK PORTABLE (top) and the coil winding that is the heart of circuit (Fig. 1). See page 3.

THE 3-CIRCUIT TUNER YOU CAN LOG

For Maximum Amplification Without Distortion and Tube Noises use the well known

Como Duplex Transformers

Push-Pull

Send for Literature

COMO APPARATUS COMPANY
448 Tremont Street Boston, Mass.

THE DAVEN SUPER AMPLIFIER
3 Stages Resistance Coupled
Economical, Distortionless
Saves Several Hours Assembly
Use it with any Tuner



PRICE
\$15.00

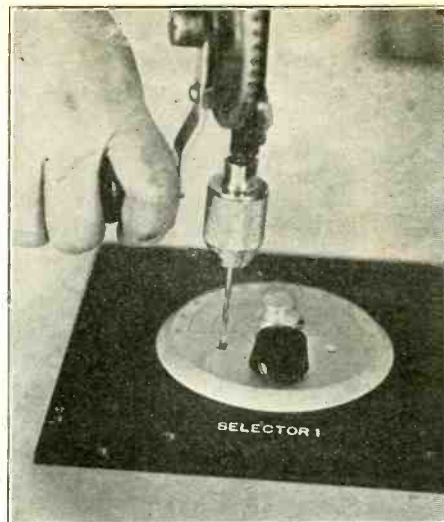

WHEN DRILLING the holes for this particular type of dial it is always a good idea to lay the dial in its proper place and drill right through it, so as to prevent any possibility of the holes being in the wrong place. (Hayden.)

GLOBE Low-Loss Tuners

Always give best results

Globe Radio Equipment Co.

217 West 125th Street New York

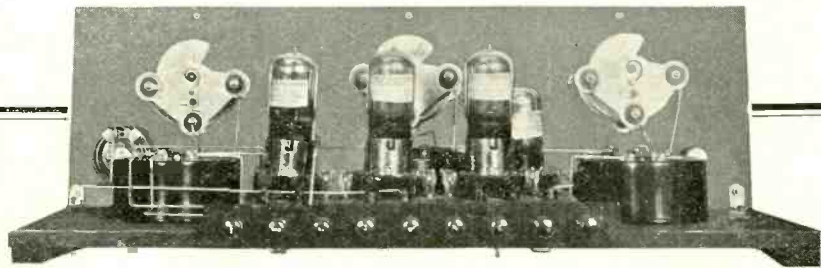

HEATH'S "RADIANT" RESISTO-FORMER

The Basis of Success of the

POWER HOUSE SET

The Radio World's "Power House Set"—the epitome of simplicity and satisfaction in radio reception—employs as the basis of its merit the "Radiant" Resisto-Former. This 3 stage coupled amplifier and Heath "Radiant" Condensers were instrumental in tuning in Dallas, Mexico, Cuba, Fort Worth and Canada while nearby stations were broadcasting. Suitable with any type of receiver. Details in article in this issue.

HEATH RADIO & ELECTRIC MFG. CO.

206-210 FIRST STREET

NEWARK, N. J.

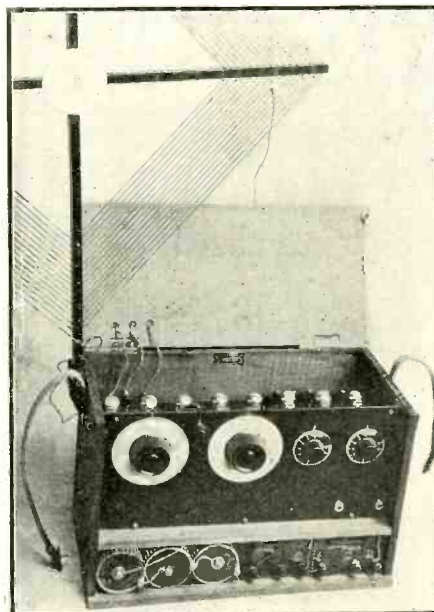

SCHNEITTER portable Super-Heterodyne, this one with 8 tubes, and used in the recent balloon races.

The Leak That Kings and Fleets Employ

This leak is used in King George's Palace and by the U. S. Shipping Board; over 270,000 sold in last four months

Fit for
a King

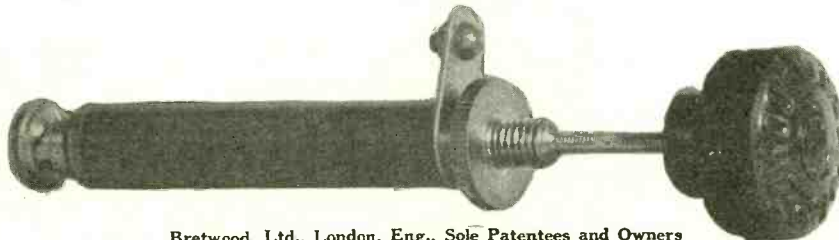

1/4 to 10
Megohms

Bretwood, Ltd., London, Eng., Sole Patentees and Owners

The BRETWOOD Variable Grid Leak

More DX, Clearer Reception, Smoother Control in Regenerative Sets Assured

The Bretwood Variable Grid Leak may be installed in any set in five minutes by single hole panel mounting.

The North American Bretwood Co., 1505 Broadway, N. Y. City

Sole Distributors for United States and Canada

NOTE TO RADIO MANUFACTURERS

Upon request, we will send any known radio manufacturer a sample of the Bretwood Variable Grid Leak.

A set with a FIXED Grid Leak may work perfectly where tested, while it needs a VARIABLE Grid Leak so that set may be adjusted to the locality where used.

THE NORTH AMERICAN BRETWOOD CO., 1505 Broadway, New York City.

Gentlemen: Enclosed find \$1.50 for which you will please send me one Bretwood Variable Grid Leak prepaid. Satisfaction guaranteed or my money back after trial within ten days of receipt by me.

NAME
STREET CITY
STATE

RADIO WORLD

[Entered as second-class matter, March, 1922, at the post office at New York, N. Y., under the Act of March 3, 1879.]

A Weekly Paper Published by Hennessy Radio Publications Corporation from Publication Office, 1493 Broadway, New York, N. Y. Phones: Lackawanna 6976 and 2063

Vol. VII. No. 14. Whole No. 170.

June 27, 1925

15c per copy, \$6.00 a year

The Pocketbook Portable

So-Called Because It Fits In the Kind the Ladies Carry—Also Makes a Very Slight Dent in Any Kind.

By Burton Lindheim

Photographs by Herbert E. Hayden

THE compact Pocket Book Portable has over-all dimensions $9\frac{1}{2} \times 6\frac{1}{2} \times 2$ "', no greater than those of the same-named container of powder, rouge and—incidentally—coin and currency normally carried by the fair sex. This 4-tube receiver is very inexpensive to make. Due to the purifying qualities of one stage of tuned radio-frequency amplification, the tonal perfection of a crystal detector, and the freedom from distortion of three stages of resistance coupled audio-frequency amplification, the circuit has exceptional clarity. Due to the employment of maximum-variation oblong variometers, low-loss inductances especially designed for the set, the selectivity is excellent.

Special Inductance Is Used

Fig. 1 shows the circuit. No capacity is used in tuning. This is made possible by the employment of the special variometers, V1 and V2. The other constants of the circuit are: Amperite for UV 199, the tubes used; C1, fixed condenser, .002 mfd.; C2, C3, C4, fixed condensers, .005 mfd. each; R1, R3, R5, fixed resistances, 1 meg. (100,000 ohms) each; R2, fixed resistance of 1 meg. (1,000,000 ohms); R4, fixed resistance of $\frac{1}{2}$ meg. (500,000 ohms); R6, fixed resistance of $\frac{1}{4}$ meg. (250,000 ohms); and J, a single-circuit jack.

The maximum-variation oblong variometers have been designed to meet the limited space requirements. The magnetic relation between the fields is as strong as in the figure eight type variometer because the limit of strength in both cases is the proximity of the forms. The maximum-variation variometers, because their forms can be made to coincide, and thus vary from maximum to minimum, have a greater field of variation than the D coil type.

As the turns of the maximum-variation variometers are adjacent and with multi-turns on one notch, there is a distributed capacity. There exists besides this distributed capacity, the inherent capacity between the two coils. However, the capacity effects are of assistance in the tuning, the inductive variation being augmented by the capacity variation.

Making the Variometers

The variometers needed are made of cardboard or other dielectric material laid out as in Fig. 2. An oblong $7\frac{1}{2} \times 2$ "' is marked off and then divided in half vertically. This provides the stator forms. An oblong 7×2 "' is marked off and then divided in half vertically. This provides

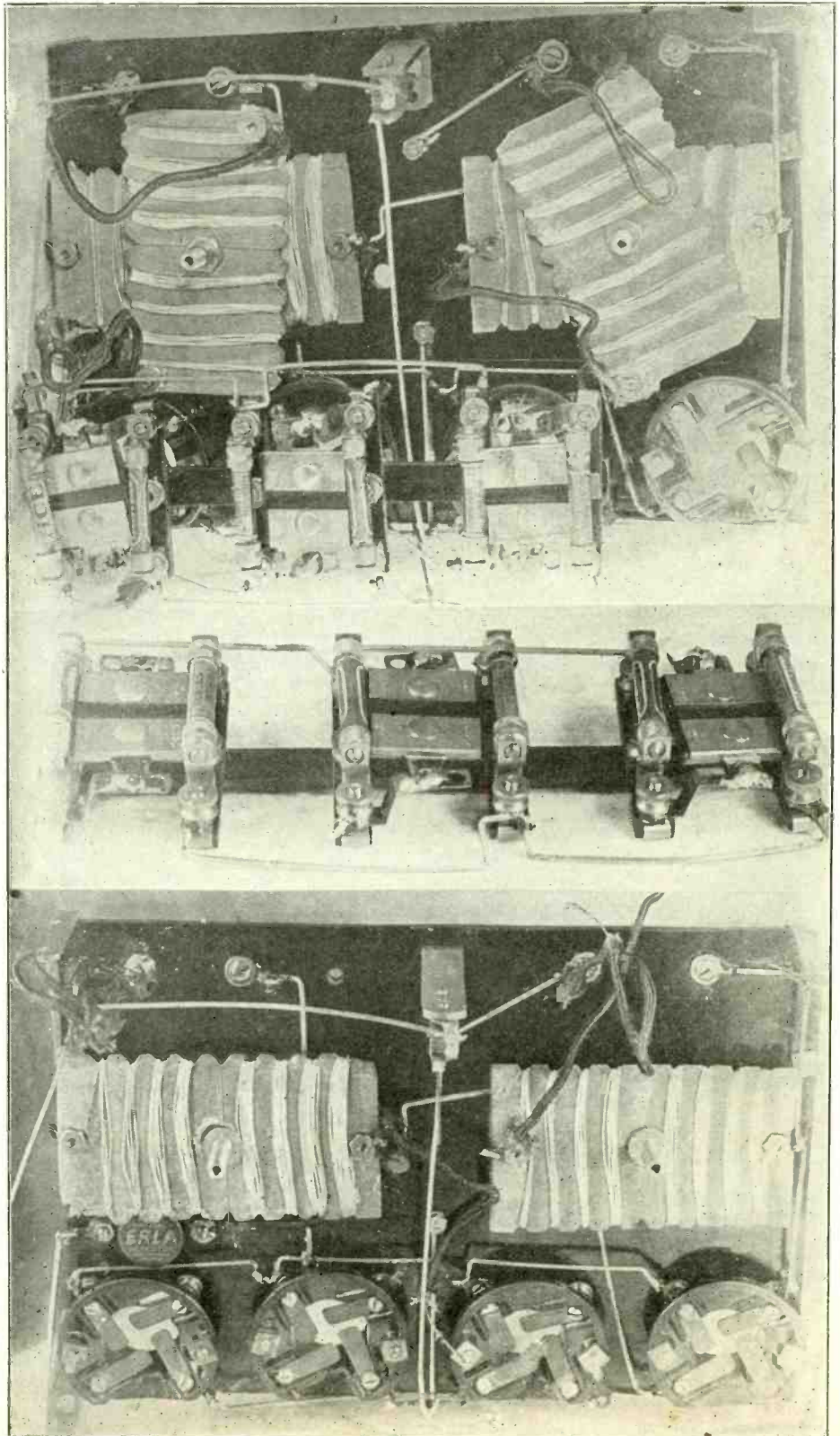

THE SOCKETS (lower photo) are sawed down, as shown, then the three resistance stages (middle photo) are incorporated, being placed under the sockets, as shown in top photo. As the set looks in use, the sockets would be at top and the tubes would point to the listener at front of panel.

Building Lindheim's Set

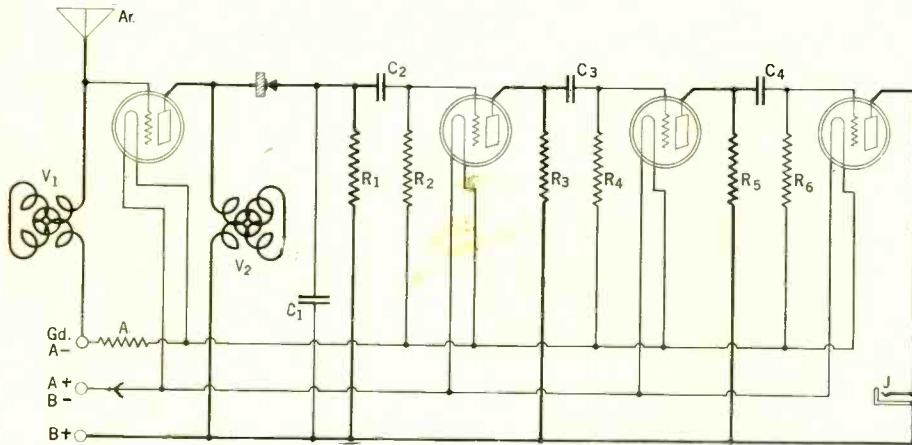
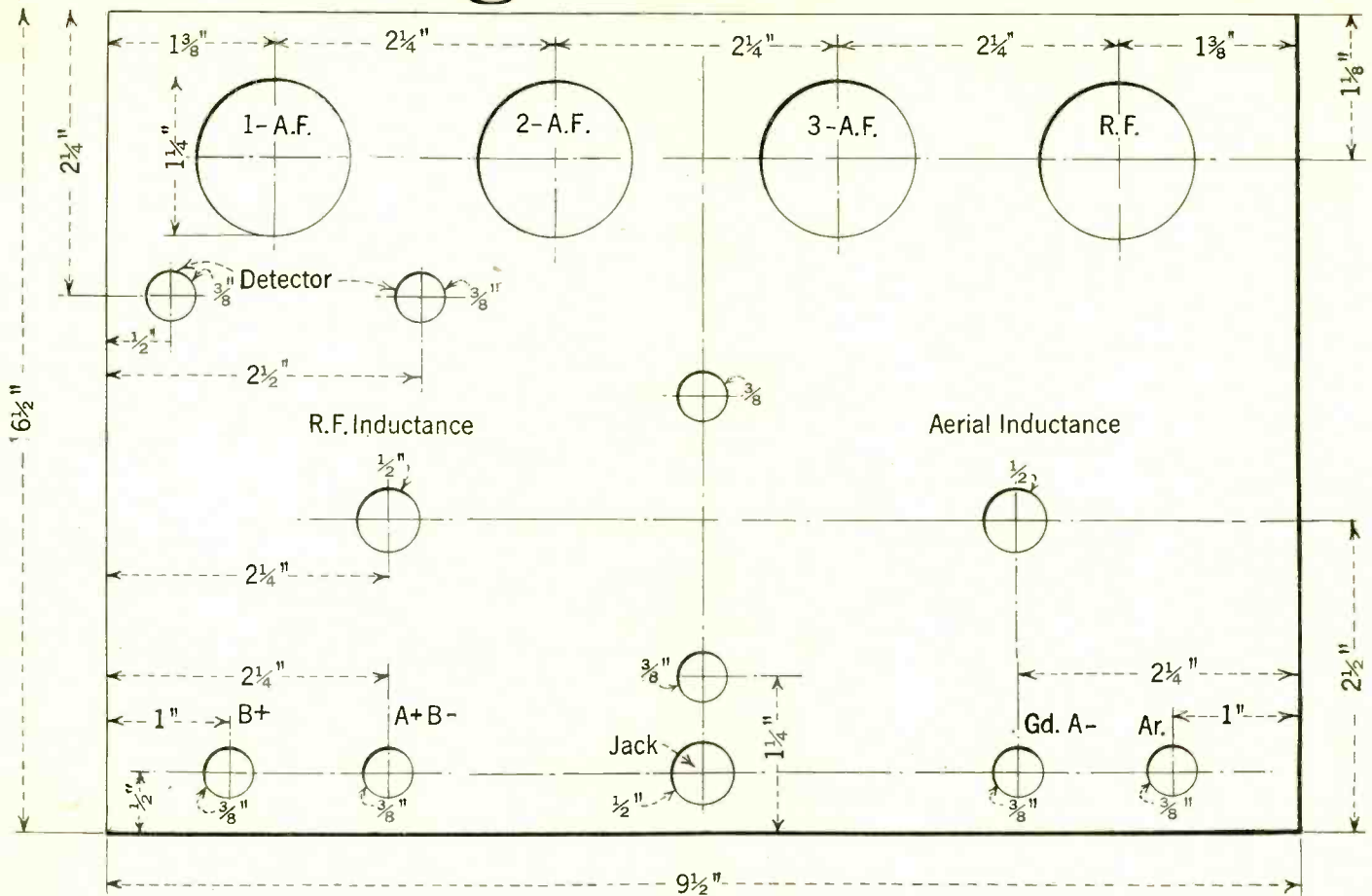

FIG. 1, circuit diagram of the Pocketbook Portable. Fig. 2, panel layout, above.

the rotor forms. Each of the four forms is next divided by 9 ruled lines into ten equal vertical sections. The forms are then matched at the top and bottom of each ruled line (Fig. 3).

The forms are now given two coats of collodion or beeswax, after which they are wound as follows: Disregarding the middle notches (between which the shaft passes), each form has eight parallel notches. Around the first pair of notches of each form wind three turns of No. 26 DCC. Continue this wire to the second pair of notches around which wind four turns. With each successive pair of notches increase the number of turns by one until at the eighth pair of notches you have wound ten turns. Then terminate and anchor the windings by making a hole at the end of the coil through which the wire is looped. No shellac is used to hold the windings.

Mounting the Parts

The parts are mounted as shown in Fig. 4. Fig. 5 shows how the inductances are mounted. The stators are secured to the panel by two nuts and screws which

pass through their ends. The rotors are held between two collars attached to shafts which pass through the center of the stators. Flexible leads are connected to the rotor and one end of each rotor is connected to one end of each stator.

The resistances are mounted as follows: On a $\frac{1}{2} \times 7$ " hard rubber strip drill at even intervals six holes through which the screws passing through the center of each individual resistance mounting are bolted. Connect three .005 mfd. or .006 fixed condensers in series between each two resistance mountings. Fig. 5 shows the top view of the completed process (Fig. 6 the bottom view). Fig. 8 shows how the strip with the resistance mountings is attached above the tube sockets. The long screws which project from the fourth and second sockets are bolted through the first and sixth holes of the hard rubber strip.

The set is now wired with bus bar strips.

Wiring Directions

1. Connect the top of V1 to aerial binding post, the bottom to the ground terminal (which serves also as the A- post).

LIST OF PARTS

- Two variometers (V1 and V2).
- Amperite type 12.
- One .002 mfd. fixed condenser (C1).
- Three .005 mfd. fixed condensers (C2, C3, C4).
- Three .1 meg. (100,000 ohms) fixed resistances (R1, R3, R5).
- One fixed resistance of 1 meg. (R2).
- One fixed resistance of $\frac{1}{2}$ meg. (R4).
- One fixed resistance of $\frac{1}{4}$ meg. (R6).
- Six resistance mountings.
- One single-circuit jack.
- One fixed crystal detector.
- Four UV 199 sockets.
- One $9\frac{1}{2} \times 6\frac{1}{2}$ " panel.
- One $7 \times \frac{1}{2}$ " strip.
- Two $\frac{1}{2}$ " shafts with collars.
- Two 3" dials.
- Four binding posts.
- Four brass brackets.
- Wire, hardware, incidentals.

2. Connect aerial to grid of RF tube.
 3. Connect A- to Amperite to F- post of RF tube to F- of 1st, 2nd and 3rd AF tubes.
 4. Connect A- to bottom of R2 to bottom of R4 to bottom of R6.
 5. Connect A+ (which is also the B- binding post to the F+ of the RF tube to the F+ of 1st, 2nd and 3rd AF tubes.
 6. Connect plate of RF tube to top of V2 to crystal detector to top of C1 to top of R1 through C2 to top of R2 to grid first AF tube.
 7. Connect plate of 1st AF tube to top of R3 through C3 to top of R4 to grid of 2nd AF tube.
 8. Connect plate of 2nd AF tube to top of R5 through C4 to top of R6 to grid of 3rd AF tube.
 9. Connect plate of 3rd AF tube to top of J.
 10. Connect B+ to bottom of V2 to bottom C1 to bottom R1 to bottom R3
- (Concluded on page 26)

Reverse Feedback Improved by Condenser Compensation

Variable Capacity Replaces Inductance Tuning in Circuit Devised by Prof. P. M. Ginnings, Head of the Physics Department, Greensboro College—He Heard Scotland on Two Tubes.

PROF. P. M. GINNINGS, head of the physics department of Greensboro College, Greensboro, N. C., has devised a reverse feedback circuit, using condenser compensation. This he finds better than the inductive feedback, in that smoother control of regeneration results.

Dr. Ginnings has obtained excellent results from this set as he sets forth: EDITOR RADIO WORLD:

I HAVE been following the articles in your magazine on the Superdyne and its modifications. In fact, I have been doing some experimenting in tuned, regenerative radio-frequency for some time. The Superdyne and its modifications have attracted me and it is certainly there when it comes to results. There is one point, in particular which I thought could be improved upon, and that is the use of an inductance for the reverse feedback. As the frequency of the receiver is varied, the value of the reverse feedback varies quite rapidly. This is because an inductance is being balanced against a capacity. Now if an inductance is balanced against an inductance or a capacity against a capacity the combination is much more satisfactory. After considerable experimentation, I have arrived at the type of circuit with a condenser-compensated or neutralized circuit (Fig. 1).

You will notice that it is a modification of a Wheatstone Bridge, two of the arms being the secondary circuit, the tube capacity one of the capacity arms, the extra condenser making up the fourth arm or capacity. Like any Wheatstone Bridge combination, over-compensation is impossible. It is highly desirable, however, to work the tube as near as possible to the point of oscillation and so just enough capacity of the extra variable condenser is used just to prevent the amplifier tube from oscillating. The procedure of operation is almost identical with that used to operate the conventional set.

One Wheatstone Bridge arm is the inductance from X to Y. The adjacent inductance arm is from Y to Z. The tube capacity from grid to plate constitutes the third arm capacitance in this arrangement while condenser C₂, made variable so that regeneration can be used, is the fourth arm of the bridge.

XY = tube cap

YZ = C₂

In operation, the grid and plate circuits are tuned to resonance with each other and to the broadcasting station. Then, if the RF tube is oscillating from the tube capacity feedback, condenser C₂ is increased from its minimum value until the point is reached when oscillation is just barely prevented. This allows the use of maximum regeneration.

For the best results from the above circuit, the best condensers and coils (such

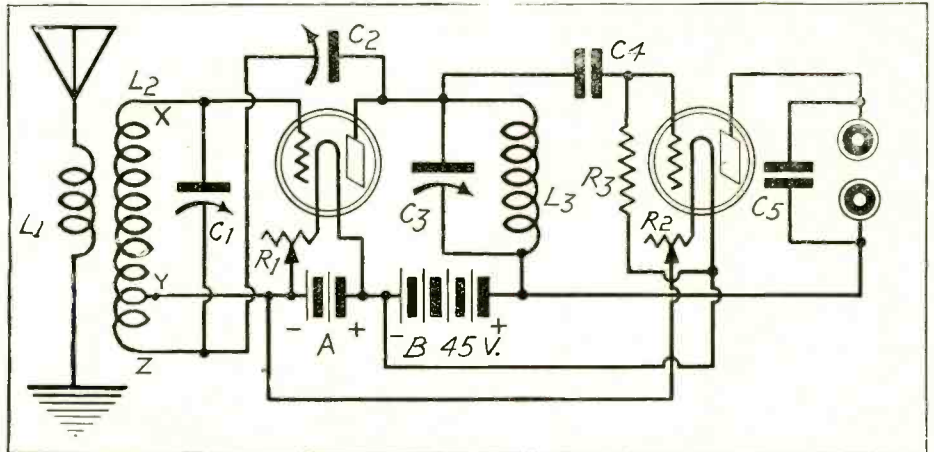

FIG. 1, the Ginnings circuit, employing condenser compensated reverse feedback.

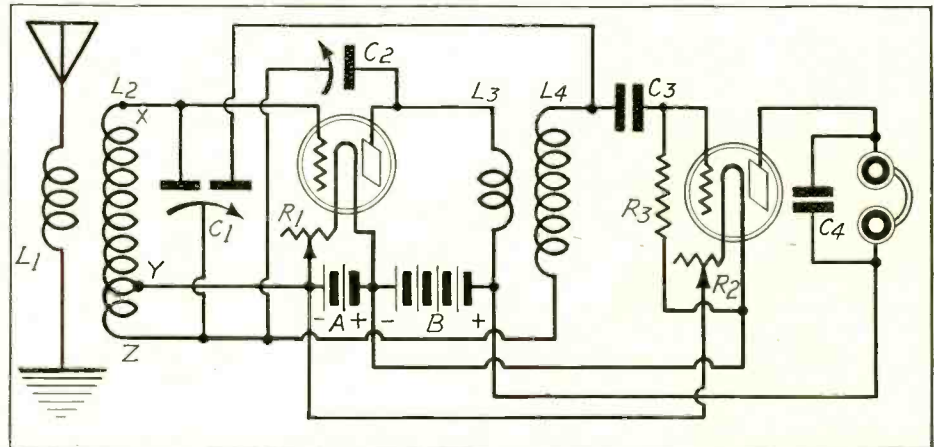

FIG. 2, the same fundamental circuit, using two controls instead of three.

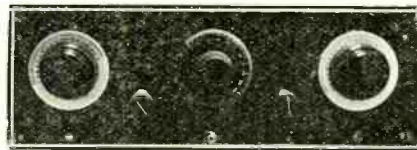

FIG. 3, how the panel would look, with RF condenser dial at left, plate dial at right and compensating dial in center.

as self-supporting, basket-weave) should be used. It is surprising how a poor coil or condenser will nullify the possibilities of a good circuit like the above.

A 2-CONTROL MODEL

Fig. 2 makes use of a double stator, single or common rotor, that Herman Bernard used in his 2-control Superdyne. The two inductances, of course, must be matched if the double stator condenser is used.

The 2-control, condenser compensated set is simpler to operate and is more selective. However, the first circuit using or requiring three controls is very good and easy to construct. About fifteen minutes' work in winding two basket-weave coils, mounting three condensers, (almost any three will work), then the usual time to connect them up and the set is ready for operation. The secondary condenser C is independent of the other two and electrically isolated but C₂ and C₃ affect each other mutually so in operation C should be set first for the wavelength, then C₂ balanced against C₃.

As to results of the above set using the Wheatstone Bridge, for a long time

I used only two bulbs and the phones. I received broadcasting stations all over the United States, Canada, Mexico, Cuba, Porto Rico, and during one evening in the trans-Atlantic tests, I heard a station in Scotland four times within an hour. The reception checked with the program broadcasted from Scotland. I didn't consider this so bad for two bulbs. Since then I have added two stages of AF with a loud speaker and now my phones are practically obsolete.

P. M. GINNINGS

The primary L₁ consists of 10 turns, the secondary of 55 turns, tapped at the 50th turn. The wire is No. 18 DCC, the diameter 3", basketweave. C₁ is .00035 mfd., C₂ is .00025 and C₃ is .0005. The plate coil consists of 35 turns of No. 18 DCC wire on a 3" diameter, basketweave.

The point Y shows where A minus (grid return) is connected, whereas the point Z is the end of the secondary and goes to the rotor of C₁.

In Fig. 2 the inductance L₁ and L₂ may be identical, but this does not assure matching. See Mr. Bernard's article on coil matching (June 13).

SOME RECENT SPECIALS

THE DIAMOND OF THE AIR AS A 2-CONTROL SET, by Herman Bernard. This is the circuit that is sweeping the country. Four tubes; loop or aerial. Send 30c for May 23 and 30 issues of RADIO WORLD, 1493 Broadway, New York City.

THE SHORT-WAVE RECEIVER REINARTZ WILL USE IN ARCTIC. Full wiring directions. Send 15c for May 16 issue, RADIO WORLD, 1493 Broadway, New York City.

The Power House Set

Special Tubes Used in Resistance AF Circuit, Ahead of Which Are a Stage of Tuned RF and a Regenerative Detector—This Set Gets DX, Too, and Is Selective—It Can Be Logged.

By John L. Munson

THE great American army of radio broadcast listeners is divided into two groups, the objects of which dictate largely the type of radio receiver they require. One class is the DX or distance fan who would rather get a single peep from a distant station amid a roar and crash of extraneous noises at 3 o'clock in the morning than listen to the most beautiful music close at hand. The other class

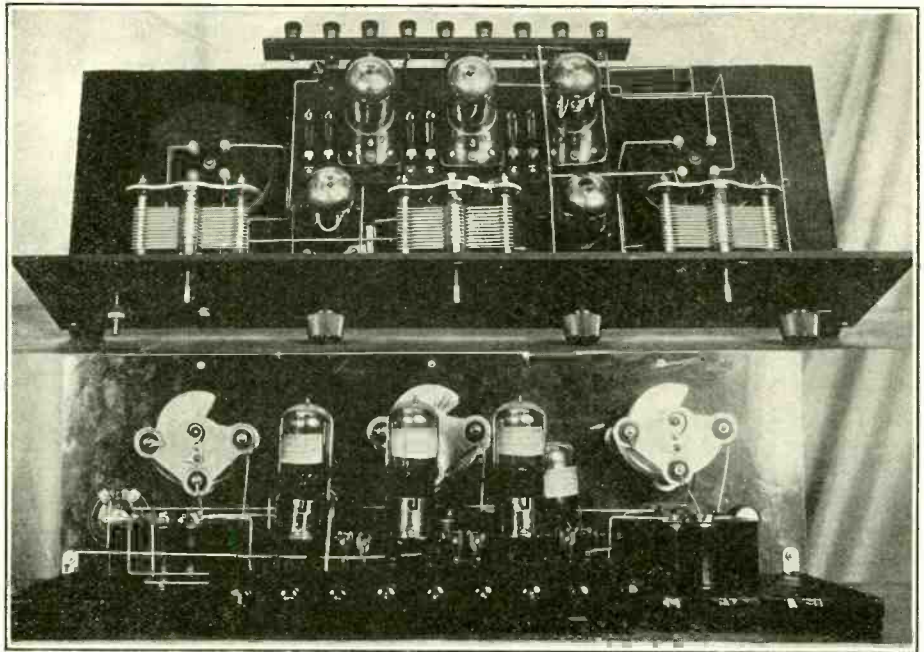

FIG. 1 (top), the assembly view of the circuit, as seen from a top angle. Lower photo (Fig. 2) is the rear view of the set.

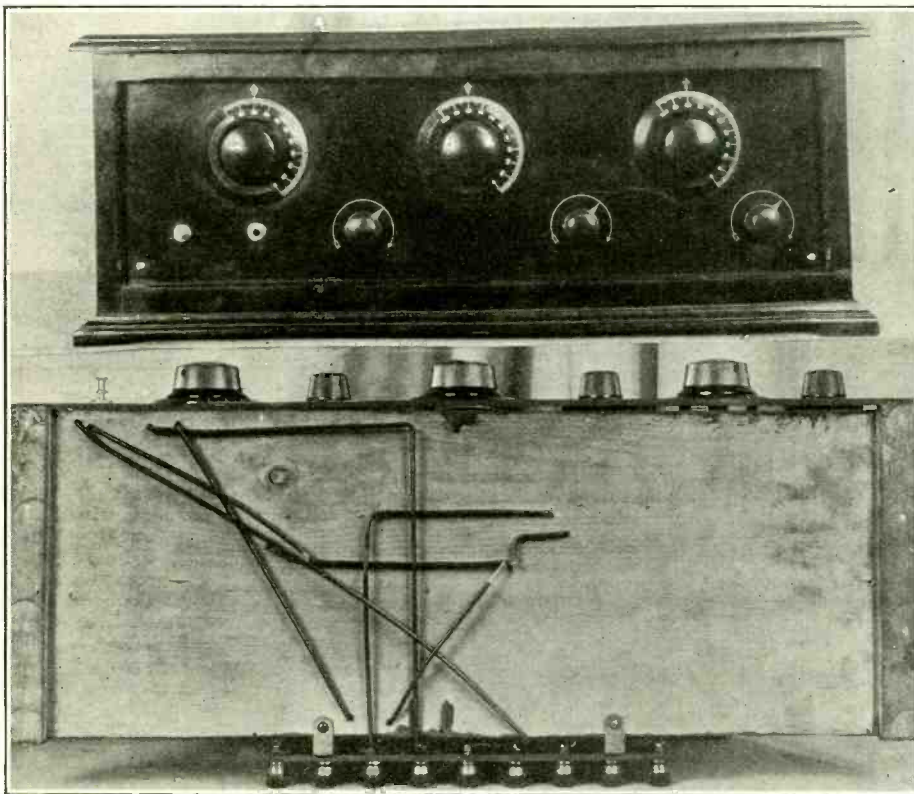

FIG. 3, the panel layout and Fig. 4, view of the bottom of the baseboard, showing battery wiring.

want absolutely the best reproduction of the music and song from nearby stations, with DX incidental. This second group demands the best for real entertainment. The quality fan is just as critical as the distance fan, for while he does not stay up late listening nervously for the call letters of a distorted, fading signal, he sits calmly back and is quick to detect a hissing of the esses and the slurring of the ares, devising new ways and means to overcome this and render the reproduction more perfect.

To this second class, the receiver (Fig. 5) is dedicated. It is designed to give the most perfect program possible in both quality and volume combined with the greatest simplicity of control. But don't misconstrue this statement as to distance for the receiver will equal a 5-tube tuned radio-frequency receiver.

In working out the design of this "Power House" set, all the existing types were investigated and their good and bad points noted. It was found that the most popular set in general use was the 5-tube neutralized and balanced receiver, employing two steps of radio-frequency amplification, detector and two steps of audio-frequency amplification. But defects were noted in such sets as follows:

1. Many receivers of this type were actually not balanced or neutralized properly
(Concluded on page 24)

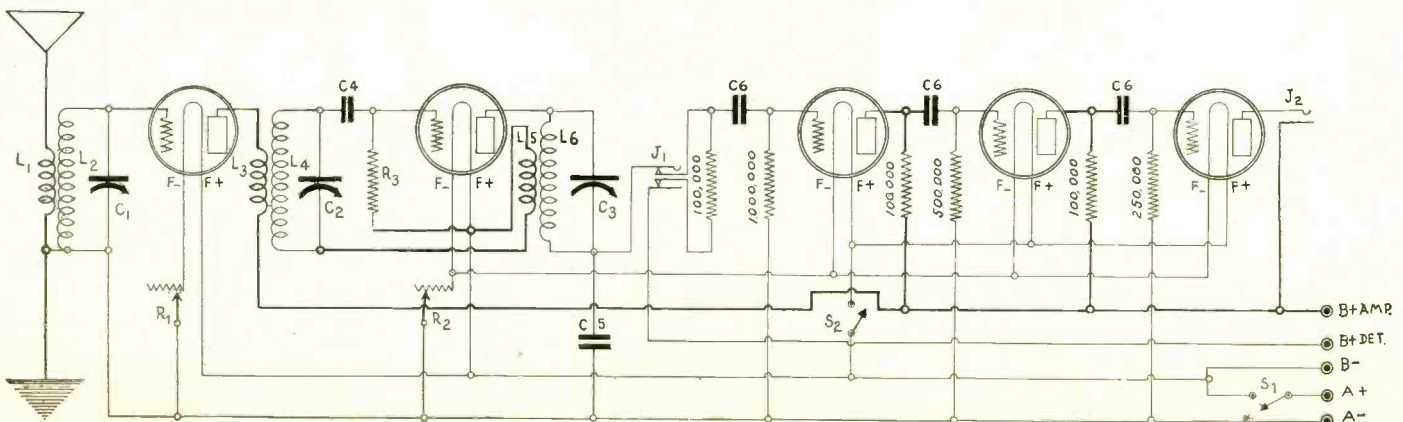

FIG. 5, the circuit diagram. If a power rheostat is on hand it may be used for R2. Otherwise R2 would control only the detector tube, while the three audio tubes would have one rheostat and S2 would be omitted. Thus there would be three rheostats and one master A battery switch, as shown on the panel (See Fig. 3). The circuit employs a tuned RF stage ahead of a regenerative detector, followed by three stages of resistance AF. Note how the secondary L4 is put in inductive relationship to L6, the plate coil. The jack J1 may be omitted.

Hooded Tips Save Tubes

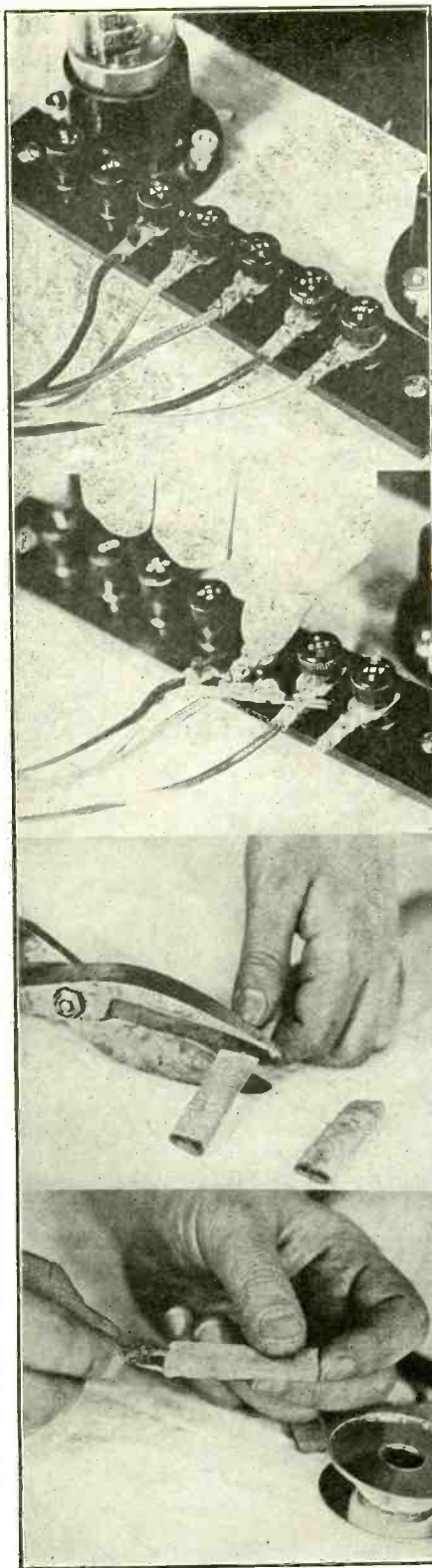

FIG. 1 (top), a close-up of a terminal strip, showing the location of the low and high voltage wires from the batteries. The cable connectors are not insulated and danger of "shorts" exists. Fig. 2—What we need is some automatic cut-off that will remember when we forget. First get a few feet of what is known as "finger-rubber." This is a very soft sort of flat rubber tubing, and is rather thin. It is very elastic. Cut pieces about 2½" long. Fig. 3—As the average connection cord to the batteries is composed of five separate leads, it will be necessary to cut only five pieces. This is done with any ordinary pair of scissors. Fig. 4, shows how to slide one of the short rubbers over the terminal of each wire. Fix it so that normally it covers the metallic portion of the connection wire.

GETTING BETTER QUALITY FROM AUDIO, by Brewster Lee. Last AF stage connected to two tubes in parallel. Send 15c for May 16 issue to RADIO WORLD, 1493 Broadway, New York City.

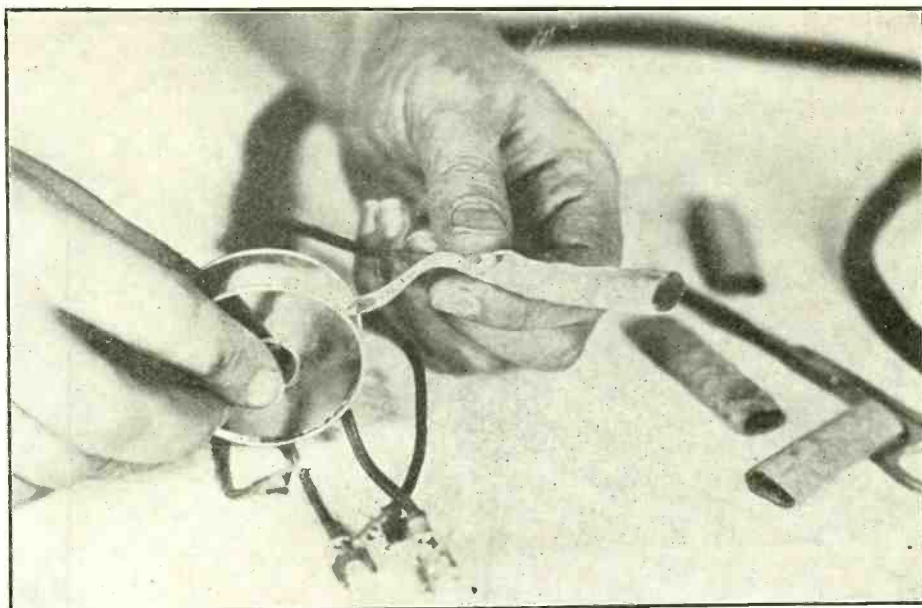

FIG. 5—Fasten the thin pieces of rubber tubing with ordinary adhesive tape. It should be placed on the wire so that normally it covers the metal end tip of the wire, in other words, the terminal.

By *Herbert E. Hayden*

Photographs by the Author



HERBERT E. HAYDEN

that there was a burning odor being emitted and soon the tube went "pop," and good-bye \$3.

To prevent this, I have devised a certain method whereby the terminal leads are thoroughly insulated from each other and the possibility of a short is removed.

As you will notice in Fig. 1, the low voltage and the high voltage terminals are very close to each other and the least little pulling of the leads toward you will cause them to short.

Take the leads off the terminal strip. Then get some "finger rubber." This is a very soft flat rubber and also kind of thin, making it a little difficult to cut, but it is very elastic. This finger rubber sometimes comes on rolls, the same way that the adhesive tape comes. Cut off about 1 foot and then divide it into five strips, each of which is 2½" in length. Stretch the pieces of rubber over the terminals, so that when it is completed all that shows out is the part that fits under the binding post.

To make a perfect insulating job of it, get some adhesive tape and wrap around each end of the terminal or over the rubber tubing.

Now when you have put the terminal leads on the binding posts, you will note that there is no possibility of the wire shorting no matter how you try to do so.

The job, when completed, looks serviceable, and can be made to look neat. Take a piece of hard rubber, the length determined by the length of terminal strip, making it about 6" wide, and place over binding posts. Drill holes in hard rubber so as to fit the set-screws of binding posts.

MANY a time a tube has been blown out through the careless handling of the battery terminals. The leads from the B batteries which had plain clips on them for connecting them to their proper terminal places had been placed or accidentally laid against the A battery terminal with the result

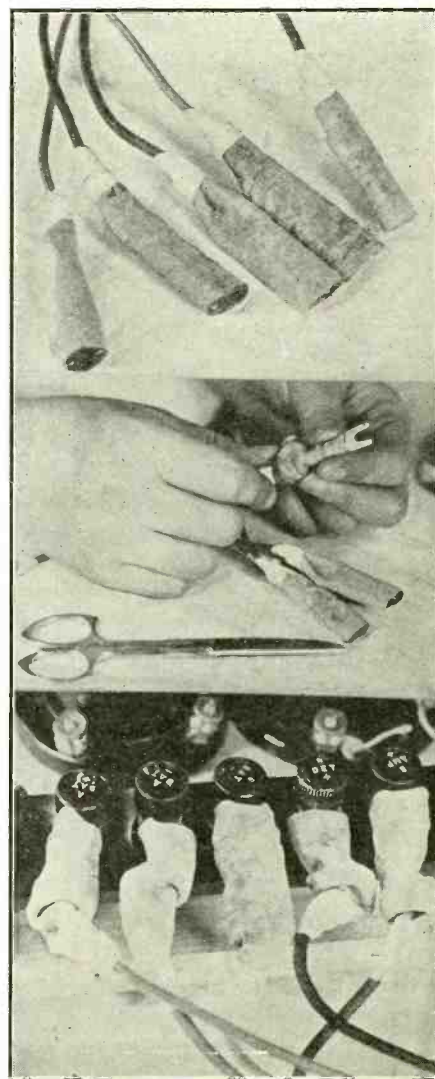

FIG. 6, a close-up of the five leads after they have been wrapped with the tape. Fig. 7. To place them on the terminal strips, push back on the tubing, exposing the terminal and fasten to the strip in the usual manner. Fig. 8. Now replace the battery leads on the terminal strip, taking care to pull back the rubber tubing before screwing down the binding post. You will find that when you remove the wires again the rubber tubing will immediately snap forward, covering the metallic terminal thus automatically preventing short circuiting of the leads.

How to Become An Amateur

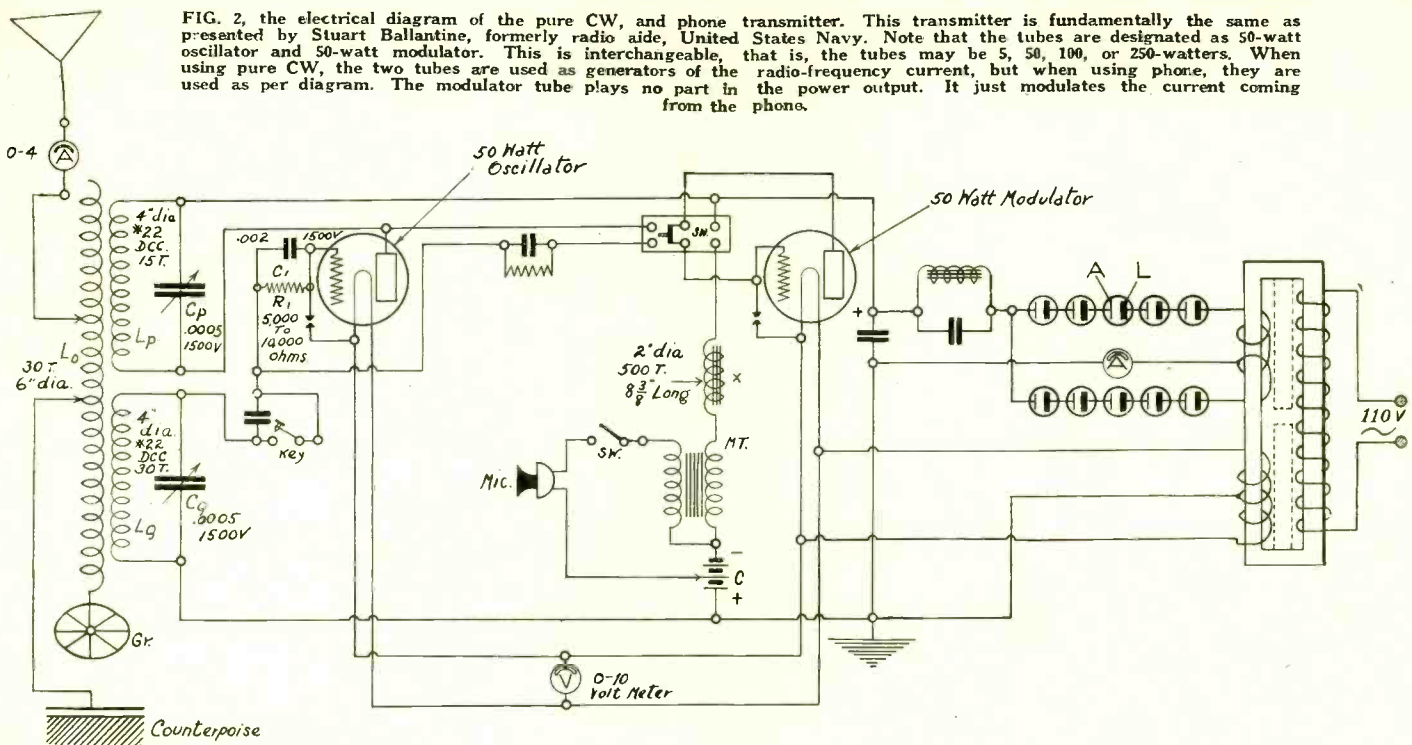

FIG. 2, the electrical diagram of the pure CW, and phone transmitter. This transmitter is fundamentally the same as presented by Stuart Ballantine, formerly radio aide, United States Navy. Note that the tubes are designated as 50-watt oscillator and 50-watt modulator. This is interchangeable, that is, the tubes may be 5, 50, 100, or 250-watters. When using pure CW, the two tubes are used as generators of the radio-frequency current, but when using phone, they are used as per diagram. The modulator tube plays no part in the power output. It just modulates the current coming from the phone.

By Lewis Winner

Radio Engineer

AFTER you have built your first radio receiver, from the data obtained in a radio magazine, and you have received loud signals from distant stations, you say: "This radio business is not so bad, after all." But, there is one part of the radio field where you can get the bigger kick and that is the transmitting end.



LEWIS WINNER

Just imagine yourself sitting back in a Morris chair, talking to your friend, who is about 1,000 miles away, and then receiving his answer almost at the same instant that you say, "Come back, O. M. or O. G."

No, this is no dream, as this is being done in a great many homes today. Of course the speakers are the proud owners of either a phone or pure CW set, either of which would do the work. The only difficult thing there is about this end of the game is that it costs quite a large amount of money. A license is required for the purpose of handling this set.

Even though there are so many "hams" in the country, there are still many persons ignorant of how to procure a license to operate such a station. I, therefore, will describe full details how to get this license, which is headed "LICENSE TO RADIO OPERATOR, AMATEUR FIRST GRADE." There is also the other license, "LICENSE TO RADIO OPERATOR, AMATEUR SECOND GRADE."

Either one of the licenses just mentioned will entitle the owner to operate a transmitting station. For the Amateur First Grade license, the first requirement is to learn the code, which is not very difficult, if you take your time in learning it and also learn it the way that I prescribe. Don't ever look at a code chart, with the code letters signified, because you will not know what to put down on your paper when you hear that letter. For instance, when you hear "dot dash" for A, you will stop and think, and then say

"dot dash; let me see. That is A." It takes about two minutes before you actually know what to put down on the paper and then you do not know if you are correct. It is better to learn the code as you actually hear it, that is, if you know that "dit dah" is A you will lose no time in putting that down as soon as you hear it. The following table is given for the benefit of those who wish to obtain the "ticket," as it is commonly called among amateur and commercial operators. The code test is 90% of the examination, which by the way is held every Tuesday, Thursday and Saturday at 9 A. M., at the Custom House, Bowling Green, N. Y. C., for the Second District only. The country is divided up into nine districts, as follows:

District 1—Boston, Mass.; takes in the following territory: Maine, New Hampshire, Vermont, Massachusetts, Rhode Island, Connecticut.

District 2—New York, N. Y.: New York (county of New York, Staten Island, Long Island, and counties on the Hudson River to and including Schenectady, Albany, and Rensselaer) and New Jersey (counties of Bergen, Passaic, Essex, Union, Middlesex, Monmouth, Hudson and Ocean).

District 3—Baltimore, Md.: New Jersey (all counties not included in the second district), Pennsylvania (counties of Philadelphia, Delaware, all counties south of the Blue Mountains, and Franklin County), Delaware, Maryland, Virginia, District of Columbia.

District 4—Savannah, Ga.: North Carolina, South Carolina, Georgia, Florida, Porto Rico.

District 5—New Orleans, La.: Alabama, Mississippi, Louisiana, Texas, Tennessee, Arkansas, Oklahoma, New Mexico.

District 6—San Francisco, Cal.: California, Hawaii, Nevada, Utah, Arizona.

District 7—Seattle, Wash.: Oregon, Washington, Alaska, Idaho, Montana, Wyoming.

District 8—Detroit, Mich.: New York (all counties not included in second district), Pennsylvania (all counties not included in third district), West Virginia, Ohio, Michigan (Lower Peninsula).

District 9—Chicago, Ill.: Indiana, Illinois, Wisconsin, Michigan (Upper Peninsula), Minnesota, Kentucky, Missouri,

Kansas, Colorado, Iowa, Nebraska, South Dakota, North Dakota.

For the information as to the time schedule of the examinations in the different districts of the country outside of the 2nd District, address all communications to the Commissioner of Navigation, Department of Commerce, Washington, D. C.

For those interested in the First Class Ticket the "exam" is a written one and the person must present himself the day that he wishes to take it. If he cannot present himself or (e. g., if he lives too far away) and he can satisfy the examining officer or Radio Inspector, he will be given a Second Class Ticket. The requirements for this one are the same as that for the First Class Ticket.

Study the code tables carefully. After you think that you know all the letters in the alphabet, get yourself a telegraph key (try J. H. Bunnell & Co., 32 Park Place, N. Y. C.) getting in addition either a high-frequency buzzer, made by the Federal Company, Buffalo, N. Y., or an ordinary bell-ringing buzzer, and a couple of dry cells. The wiring up of the instrument is very simple. Connect one end of the buzzer to a terminal of the A battery (plus or minus), connect the left-off end of the A battery to the key, and he other terminal of the key to the buzzer.

Put your index and middle fingers on the flat part of the key, and your thumb underneath this part. Do not press heavily. Use wrist movement when pressing key. First send the letter A, which will be according to the chart a short and a long, or dit dah. Practice each letter about five times and then have somebody send to you the whole alphabet slowly. DO NOT EXPECT TO LEARN HOW TO RECEIVE THE COMPLETE ALPHABET THE FIRST TIME THAT YOU TACKLE THE SAME. It will take about three or four months to master the alphabet so that you will be able to receive words at a rate of 18 a minute, provided you have some friend send to you for about 1 hour every day and you do the same to him. When sending, do not attempt to be fast, as any one can send fast, but not every one can send fast and accurately and also receive fast at the beginning. Always send as fast

Lesson on Learning the Code

Here are the special code tables:

Letter	Code Letter
A	Dit dah.
B	Dah dit dit dit.
C	Dah dit dah dit.
D	Dah dit dit.
E	Dit.
F	Dit dit dah dit.
G	Dah dah dit.
H	Dit dit dit dit.
I	Dit dit.
J	Dit dah dah dah.
K	Dah dit dah.
L	Dit dah dit dit.
M	Dah dah.
N	Dah dit.
O	Dah dah dah.
P	Dit dah dah dit.
Q	Dah dah dit dah.
R	Dit dah dit.
S	Dit dit dit.
T	Dah.
U	Dit dit dah.
V	Dit dit dit dah.
W	Dit dah dah.
X	Dah dit dit dah.
Y	Dah dit dah dah.
Z	Dah dah dit dit.
Period	dit-dit dit-dit dit-dit.
Semicolon	Dah dit dah dit dah dit.
Comma	Dit dah dit dah dit dah.
Colon	Dah dah dah dit dit dit.
Interrogation	Dit dit dah dah dit dit.
Exclamation Point	Dah dah dit dit dah dah.
Apostrophe	Dit dah dah dah dah dit.
Hyphen	Dah dit dit dit dit dah.
Parenthesis	Dah dit dah dah dit dah.
Inverted Commas (quotes)	Dit dah dit dit dah dit.
Distress Call	Dit dit dit dah dah dah dit dit.
Attention Call to Precede Every Transmission	Dah dit dah dit dah.
From (de)	Dah dit dit dit.
Invitation to Transmit (go ahead)	Dah dit dah.
Wait	Dit dah dit dit dit.
Break	Dah dit dit dit dah.
Understand	Dit dit dit dah dit.
Error	Dit dit dit dit dit dit dit.
O. K.	Dah dit dah.
Cross	Dit dah dit dah dit.
Transmission Ended	Dit dit dit dah dit dah.

as you can receive, that is if you can receive at about 15 words per minute, send at the same rate.

After you have learned the alphabet and you can receive straight press material, that is, reading matter, it is a good idea to learn how to send messages. When you take your examination you will not receive the code test from a hand key. It will be sent to you from an automatic omnigraph, which has a peculiar way of sending, that is, the sending is sort of chopped up, but if you are positive of your characters you will pass the "exam" without any trouble whatsoever. It is the fellow who cannot receive very well who, when he goes down to the Custom House, kicks about the way the omnigraph sends.

After you have the code down pat it is necessary to pick out the transmitter and the receiver that you will describe down there, as the theoretical part of the exam, consists of a diagram of the set that you are going to use for transmitting and receiving, and the following queries: how to calibrate your receiver and your transmitter to a specific wavelength, what to do in case of an S O S, describe your transmitter, and certain laws and regulations. The data for the last question can be obtained by enclosing 15c in an envelope and asking for a copy of "Radio Communication Laws of the United States and

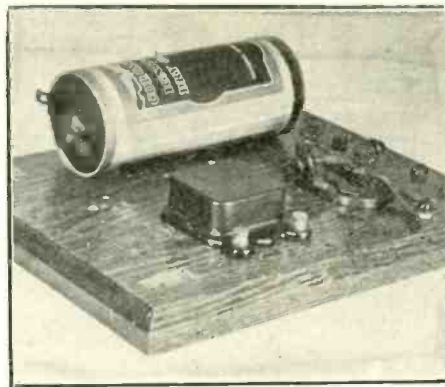

FIG. 1, how a practice code outfit looks. The buzzer is an ordinary bell ringing buzzer.

the International Radiotelegraphic Convention," addressing this communication to the Superintendent of Documents, Government Printing Office, Washington, D. C. The code test will last five minutes and the speed will be at rate of not less than 10 words per minute, five characters to a word. A perfect score of 100 characters must be made, otherwise you flunk and cannot take the theoretical part of the test. Now for what transmitter you shall describe. I personally think that if you are going to build a transmitter, you might as well build the best that can be built and my choice is the set employing the Meissner circuit, with the Heising system of modulation, employing the transformer-rectified filter method for the purpose of supplying plate current to the tubes. This transmitter is very inexpensive to build and very capable of reaching out. It has two tubes, each of which may be of any of the following list:

Type of tube	Power (Watts)	Filament Voltage	Filament Amperage	Plate Voltage	Plate Milliampere
202	5	7.5	2.35	350	50
203	50	10	6.50	1000	150
203A	50	10	3.25	1000	125
204	250	11	14.75	2000	250
204A	250	11	3.85	2000	200

An example of a circuit like Fig. 1 is found in the Western Electric Broadcast-

ing equipment. There are two 250-watt tubes used for modulating the current, and there are two tubes used as oscillators. The oscillators are connected up in parallel and so are the two modulators. You can put a great many tubes in parallel, up to a certain point, and beyond that point the plate resistance of the tubes becomes too low, and it is desirable to use a higher powered tube, with a very big plate resistance and amplification factor. I think the best thing to do is to use one single tube for large power output (excluding modulator), precaution being taken as to the proper fusing of the line, etc., so the filament will not be burned out, as these "babies" cost "some" money.

Fig. 2 shows the diagram of the transmitter. About the most expensive things in the set are the tubes and the microphone, which may be a Kellogg Mike. The voltage for the plate of the tubes may be piled up from a AC step-up transformer, which may be bought or home-made. Details will be given later. All the other material in the set is to be made and will be described. The following is a list of the parts necessary in this set. When using more than 10 watts, the only difference is in the power units, that is there is more plate current, more filament voltage, large protective resistances, and higher reading meters. For the present let's use a 10-w. CW set. The ammeter should read from 0 to 4 amperes; the grid and plate condensers have a capacity of .0005 mfd., and which will withstand a voltage of at least 1500, without puncture. The voltmeter should also read from 0 to 10. The coils are home-made. Two good heavy porcelain sockets for the tubes are essential. The changeover switch should be of the DPDT type and be a very high current carrying type. The small arrows between the grid and the filament of both tubes are safety gaps, separation about 1/4". This is inserted to prevent the sudden surge of current which takes place in the grid circuit when the key is depressed, and thereby cause the filament to be destroyed. The grid condensers are .002 mfd., having a load carrying property of 1500 volts. The grid leak is an 8000 ohm resistance. This applies to the other grid condenser and the grid leak. A key, a modulation transformer, an AC step-up transformer, a dozen fruit jars, a few 1 mfd. fixed condensers, a good microphone, a 7 x 28" panel, a 7 x 28 cabinet to fit, two dials, switches and a terminal strip are needed.

Static's Good for Something; Available as a Storm Prophet

ONE of the peculiarities of heat waves in New York City, has been the absence of static, which generally accompanies hot weather and torments radio listeners. Day and night reception was clear. Wireless operators can usually tell within a few hours when a storm will break, because of the increase in the intensity of static.

There are two kinds of static, "grinder" and "click." Both have been absent for over a week. The "grinder" static generally prevails in the evening at this season of the year and it is more or less national in scope. The sharp "clicks" which distinguish the second type are caused by lightning flashes of a local storm. When either appears again it is likely to be a good indication that the end of the hot wave is near, according to wireless operators.

So sure is static as a storm forecaster

that the New York Edison Company has a radio storm detector on the roof of their waterside station at Thirty-eighth Street and the East River. A regular radio antenna is used, but its function is to warn of approaching weather disturbances and thus prevent the city from being plunged suddenly into darkness. The antenna is connected to a device known as a storm detector, with bell-ringing apparatus. When the static gains strength enough it rings the bell, and the operator on watch knows that it is time to arrange to have more current generated to meet a sudden lighting load.

As the storm approaches the bell rings more often, because the static is heavier. When the average electrical storm is within two hours of the city the bell rings about once every half minute. At this point the operator orders the auxiliary boilers into service. The efficacy is excellent.

LETTER FINDS ITS HOME



Here is how a letter was "addressed." It was dropped in a Chicago post box. The return address was omitted, but not the addressee's. Instead, the nameplate of The Diamond of the Air was pasted on. The letter (containing a subscription check) reached RADIO WORLD at its main office, New York City, due to the diligence and efficiency of the Chicago and New York post offices. The mailing stunt is all right—once!

This Nameplate FREE



A BEAUTIFUL colored nameplate to put on the panel of the Diamond of the Air will be furnished free to all. Send in your request now, if you haven't done so before.

Directions for Use

Take the nameplate and immerse it for two minutes in a glass of water, making sure that the entire nameplate is covered with the water. When you insert it in the water, the paper will coil up and only after it starts to uncoil, take out and place on a piece of blotting paper. Take dull knife and lift off the nameplate gently, to get it transferred to the blotter. Do not injure the nameplate. You won't if you take care. On your panel draw a line representing where the top of nameplate is to go. By coiling back the blotter or other piece of absorbent paper you can see the nameplate top sufficiently to justify it with the line on the panel. Press firmly and nameplate will stick to panel. Allow to dry.

The decalomania has to be removed from the paper to avoid putting it on the panel with the lettering reading backward.

All nameplate requests received up to the moment this issue went to press have been complied with, so if you didn't get your nameplate, please write to Nameplate Editor, RADIO WORLD, 1493 Broadway, New York City.

"DIAMOND BEATS 'EM ALL," VERDICT OF TEXAS FANS

RESULTS EDITOR:

I CONSTRUCTED the 4-tube Diamond of the Air, as described in May 23 and 30 issues of RADIO WORLD, and to say that it is good would be putting it mildly. Last night I got the following on the speaker with volume: KDKA, Pittsburgh; WLS, Chicago; WMAQ, Chicago; WDAF and WHB, Kansas City; New Orleans, Houston and Beaumont, as well as Dallas and Ft. Worth, Texas. I have built several kinds of 4 and 5-tube machines but the Diamond of the Air beats them all for perfect radio reception. I use a D Coil as described in Wireless Age for the antenna circuit and a home-made 3-circuit tuner, with Bremer-Tully condensers. I am going to build the Diamond of the Air of low-loss parts throughout and keep it for my own use.

W. D. RICKETTS,
Queen Theatre Bldg.,
Sherman, Tex.

NAMEPLATES

- Walter H. Brown, 867 Maine St., Honesdale, Pa.
- Roy Page, 2808 Semn Ave, Richmond, Va.
- R. C. Clarck, P. O. Box 184, Gainesville, Fla.
- W. H. Moulton, 309 Davis St., Portland, Ore.
- George Steels, 214 Houston St., Ripon, Wis.
- E. D. Gawn, 664 Franklin, Amherst, O.
- Wm. Haskell Jr., Ferguson, Ia.
- E. E. Emond, 268 Cornelia St., Brooklyn, N. Y.
- Mrs. Mac J. Lewis, 1231 Westside Ave., Honesdale, Pa.
- John Urbaneck, 13 Middagh St., Winfield, N. Y.
- Frank Kchop, 24 Middagh St., Winfield, N. Y.

- A. Boyd, 727 56th St., Oakland, Cal.
- W. D. Criss, 1201 West 4th St., Oklahoma City, Oklahoma.
- Alex Horvath, 2658 Grand Ave., Cleveland, O.
- F. C. Meisler, 1331 Central St., Kansas City, Mo.
- Cecil Hill, 402 1/2 Luckie St., Atlanta, Ga.
- Michael Mayerle, 401 Harper St., Detroit, Mich.
- F. A. Jones, Wright, Kan.
- George Kelsey, 4178 Lenox, Detroit, Mich.
- Rea Haill, 6570 Seanlan Ave., St. Louis, Mo.
- Ed. W. Brown, 21 Santa Cruz Ave, San Francisco, Cal.
- Fred C. Shivers, Lexington, Neb. (Dealer).
- Chas. A. Heyck, Box 1003, Corpus Christi, Tex.
- A. M. Cannon, Box 67, Peebles, O.
- Joseph Rebello Jr., 94 Armour St., New Bedford, Mass.

JAMES F. KERR DIES

JAMES F. KERR, general manager of the Second Radio World's Fair, died in the Fifth Avenue Hospital, New York City, following an abdominal operation. Mr. Kerr, who was 48 years old, began his career as an actor in 1897, but soon drifted into the managerial end of the business. He managed such stars as De Wolf Hopper, James K. Hackett, Mme. Nordica, Macllyn Arbuckle, Alice Neilson, Mme. Melba, Donald Brian, Taylor Holmes and Frank Daniels. Prior to entering the radio field in 1922 he was with productions of "The Better 'Ole" and "The Bat." He leaves a widow, whose stage name is Edith Williams.

THE DIAMOND OF THE AIR AS A 2-CONTROL SET, by Herman Bernard. This is the circuit that is sweeping the country. Four tubes; loop or aerial. Send 30c for May 23 and 30 issues of RADIO WORLD, 1493 Broadway, New York City.

Roxy Creeping Up on Bernie

ROXY is gaining votes in the popularity contest conducted by RADIO WORLD. He has been occupying second place quite steadily, with Ben Bernie and his orchestra comfortably first. But Roxy is cutting down the lead. Karl Bonawitz, WIP, Phil-

adelphia, is running third, with a chance of passing Roxy. Next week a tally sheet will be printed. Watch for this! See just how the contestants stand! And remember—only four more weeks of the contest!

RADIO WORLD'S POPULARITY CONTEST

To Determine the Gold Medal Radio Entertainer for 1925
Popularity Editor, RADIO WORLD, 1493 Broadway, N. Y. C.

I hereby cast one ballot for:

(Name of Entertainer).....

(Entertainer's Station).....

(Voter Sign Full Name Here).....

(Street and Number).....

(City)..... (State).....

No. 12-6-27. FILL OUT THIS COUPON AND MAIL NOW!

Contest Rules

1. The votes in RADIO WORLD'S 1925 contest to determine the radio entertainer entitled to the popularity gold medal may be cast by filling out the coupon as published weekly in RADIO WORLD. One coupon entitles the sender to one vote. The coupon should be properly filled out and mailed. Anybody subscribing to RADIO WORLD (a new subscriber or one renewing an existing subscription), may cast as many votes as are represented by the total number of weeks of the new or renewed subscription. In addition, as the coupons are published, the subscriber may use them for sending in one vote on each such coupon. When subscribing, cast your total subscription votes by specifying the candidate in the subscription order.
2. This contest closes July 31. The last coupon will be published in the July 25 issue.
3. In case of a tie, a gold medal will be awarded to each contestant so tied.

Experiments With Bernard's 3-Circuit Tuner You Log

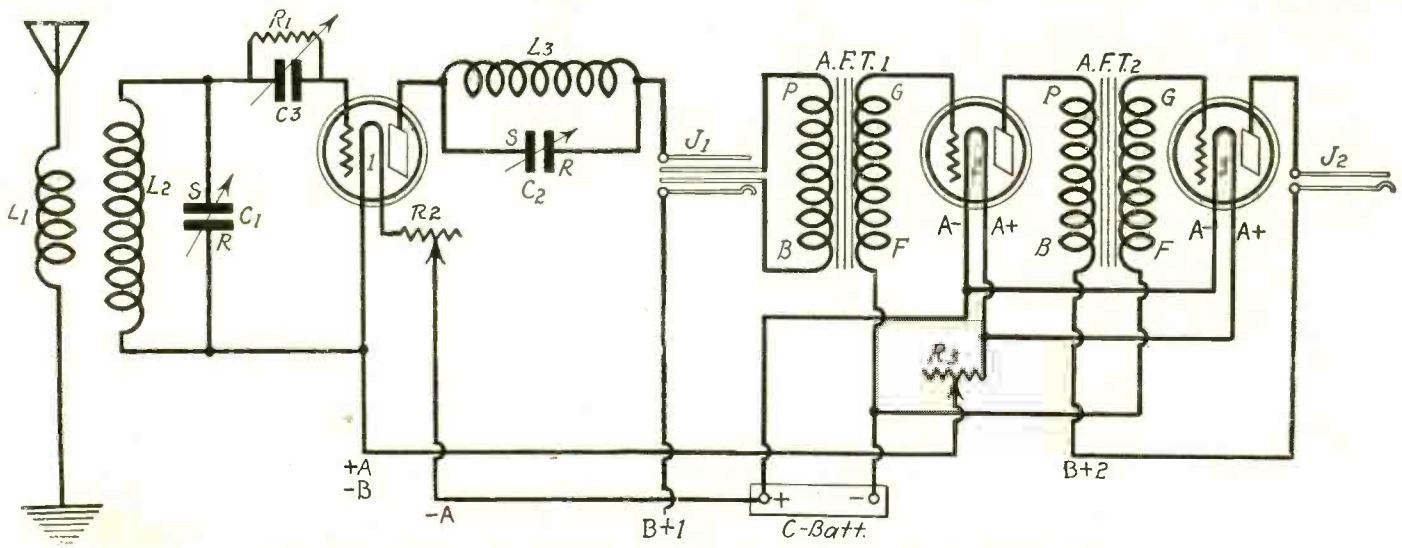

FIG 1, the diagram of the 3-circuit Tuner you log. B plus No. 1 is the detector voltage.

By Capt. P. V. O'Rourke



CAPT. O'ROURKE

THE combination of virtues in the 3-Circuit Tuner That You Log is so great that it is no wonder that this circuit, as described by Herman Bernard in the November 8, 1924, issue of RADIO WORLD, was a great success. Even old-timers build this set, for their own use, because they know how good it is, when rated on the results basis.

This set is one of the simplest DX speaker circuits, hence appeals also to the novice. It requires only three tubes—one for detector, two for audio—and gives all that three tubes can give no matter what circuit is used.

There are a few kinks that may arise in the construction of this set and most of them concern the regeneration control.

Helps Regeneration

In the first place, the wiring diagram (Fig. 1), which is republished exactly as it appeared in the November 8 issue, shows no by-pass condenser across the audio of the first audio transformer or from plate to A minus. None should be needed, if one has a lively tube, that is, one eminently suitable as a detector. But tubes do not justify the assumption that even the majority of them are quite up to snuff. Therefore, if any regeneration deficiency arises, the by-pass condenser should be connected across the outside springs of the jack (plate and B plus detector leads) or from the rotor of C2 to minus A. The rotor referred to represents the same lead joining to the outside jack spring that makes contact with plate.

Either way of by-passing is good. The safer way, when one is not quite sure of the by-pass condenser being rugged, is to place it "across the phones," the position equivalent to the primary of the first audio transformer. Thus one side of this condenser connects to the P post, the other side to the B post, although the condenser is actually affixed to the

jack springs, as previously stated, so that it will be in play even when the first audio transformer is cut out. In other words, when listening on ear phones at the detector output, you will still be by-passing the radio-frequency current.

The inclusion of this condenser from the end of the plate coil to A battery minus by-passes the batteries, as well as the phones of the audio primary, which is theoretically better, but then one runs the risk of ruining all three tubes by blowout if that by-pass condenser is shorted. The safer way, then, is across the outside jack springs. It should be .001 or .002 mfd.

Either method of by-passing may affect the settings of the condenser C2. This tunes the plate coil L3, so that resonance with the grid circuit is produced, and the plate current returned to the grid through the capacity effect between those two elements above the base of the tube. The stems of the elements are brought through the glass on their way to the base, and here the capacity is set up, each element being like the plate of a condenser. Indeed, such it is.

The circuit as originally presented by Mr. Bernard called for .00035 mfd. variable condensers, both for C1 and C2. The diagram shows rotor plates designated R and stator plates S. Of course it is not vital to use just this value of condenser,

and if you have smaller or larger ones handy, you may make up the difference by winding the coils accordingly. For smaller capacity condensers there must be more turns on L2 and L3, for larger capacities, fewer turns.

Bernard's Original Coil Data

So that readers will have the coil-winding directions just as Mr. Bernard gave them in the November 8 issue—which, I understand, is out of print—I quote them:

"The directions for winding the coils are based on my own experiences with the set I built. As all experimenters know, the fact that one person used a certain 17-plate condenser does not mean that somebody else's 17-plate condenser of different make has the same maximum and minimum capacity. The difference usually is not much, but still differences must be allowed for, hence the constructor may find that a few turns more or less will bring the same results as I obtained. Therefore in winding the coils it would be advisable in the case of the secondary L2 and the plate coil L3 to include five or six more turns than I specify, in case your condensers do not come up to the actual maximum capacity of the ones I used. Then you can remove turns as found necessary and by the same arrangement so combine coils and condensers that the secondary and

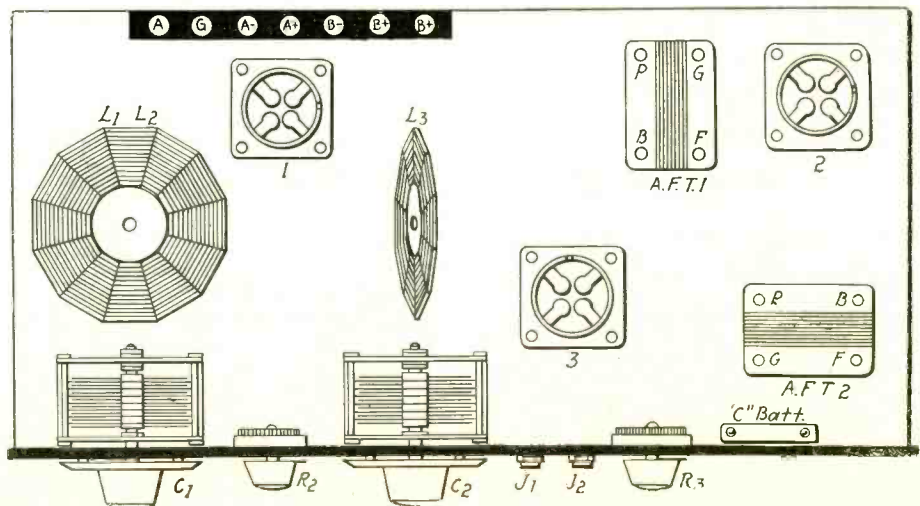

FIG. 2, the baseboard layout, with panel suggestion at bottom.

THE KEY TO THE AIR

(Continued from preceding page)

WHN, New York City, 360 (ESTDS)—1 PM to 1:30; 3 to 6; 10 to 12.
 WHT, Chicago, Ill., 238 (CSTDS)—9:30 AM to 1:15 PM; 5 to 9.
 WIP, Philadelphia, Pa., 508.2 (ESTDS)—10:45 AM to 12:30 PM; 3:30 to 4:30.
 WKRC, Cincinnati, O., 326 (EST)—6:45 PM to 11.
 WNYC, New York City, 526 (ESTDS)—9 PM to 11.
 WMCA, New York City, 341 (ESTDS)—11 AM to 12:15 PM; 4 to 5; 7 to 8.
 WOCL, Jamestown, N. Y., 275.1 (EST)—9 PM to 11.
 WPG, Atlantic City, N. J., 299.8 (CSTDS)—3:15 PM to 5; 9 to 11.
 WQJ, Chicago, Ill., 448 (CST)—10:30 AM to 12:30 PM; 3 PM to 4; 8 to 10.
 WRNY, New York City, 258.5 (ESTDS)—3 PM to 5; 7:59 to 10.
 WWJ, Detroit, Mich., 352.7 (EST)—11 AM to 12:30 PM; 2 to 4; 6:20 to 9.
 KDKA, Pittsburgh, Pa., 309 (EST)—9:45 AM to 10:30; 11:55 to 12 M; 2:30 PM to 5:30; 7 to 11.
 KFNF, Shenandoah, Iowa, 266 (CST)—10:45 AM to 12:30 PM; 2:30 to 4:30; 6:30 to 10.
 KOA, Denver, Col., 322.4 (MST)—10:55 AM to 12 M; 4 PM to 5:30; 7:45 to 10.
 KGW, Portland, Oregon, 491.5 (PST)—10:30 AM to 12:30 PM; 6 to 9.
 KHJ, Los Angeles, Cal., 405.2 (ESTDS)—10 AM to 12:30 PM; 6 to 9.
 KTHS, Hot Springs, Ark., 374.8 (CST)—11 AM to 12:30 PM; 2:30 to 3:40; 8:40 to 11.

MONDAY, JUNE 29

WAAM, Newark, N. J., 263 (ESTDS)—11 AM to 12 M; 7 PM to 11.
 WAHG, Richmond Hill, N. Y., 316 (ESTDS)—12 M to 1:05 PM; 8 to 2 AM.
 WAMB, Minneapolis, Minn., 243.8 (CST)—10 PM to 12.
 WBBM, Chicago, Ill., 226 (CST)—6 PM to 7.
 WBBR, New York City, 272.6 (ESTDS)—8 PM to 9.
 WBZ, Springfield, Mass., 333.1 (ESTDS)—6 PM to 11:30.
 WCAE, Pittsburgh, Pa., 461.3 (ESTDS)—12:30 PM to 1:30; 4:30 to 5:30; 6:30 to 12.
 WCBD, Zion, Ill., 344.6 (CST)—8 PM to 10.
 WCCO, St. Paul and Minneapolis, Minn., 416.4 (CST)—9:30 AM to 12 M; 1:30 PM to 6:15; 8 to 10.
 WDAF, Kansas City, Kansas, 365.6 (CST)—3:30 PM to 7; 8 to 10; 11:45 to 1 AM.
 WEAJ, New York City, 492 (ESTDS)—6:45 AM to 7:45; 4 PM to 5; 6 to 11:30.
 WEAR, Cleveland, O., 390 (EST)—11:30 AM to 12:10 PM; 3:30 to 4:10; 7 to 8.
 WEEL, Boston, Mass., 476 (ESTDS)—6:45 AM to 8; 3 PM to 4; 5:30 to 10.
 WEMC, Berrien Springs, Mich., 286 (CST)—8:15 PM to 11.
 WFAA, Dallas, Texas, 475.9 (ST)—10:30 AM to 11:30; 12:30 PM to 1; 2:30 to 6; 6:45 to 7; 8:30 to 9:30.
 WFBH, New York City, 272.6 (ESTDS)—2 PM to 6:30.
 WGBS, New York City, 316 (ESTDS)—10 AM to 11; 1:30 PM to 3:10; 6 to 7:30.
 WGES, Chicago, Ill., 250 (CSTDS)—5 PM to 8.
 WGCP, New York City, 252 (ESTDS)—8 PM to 1 AM.

WGN, Chicago, Ill., 370 (CST)—9:31 AM to 3:30 PM; 3:30 to 5:57.
 WGR, Buffalo, N. Y., 319 (ESTDS)—12 M to 12:30 PM; 2:30 to 4:30; 7:30 to 11.
 WGY, Schenectady, N. Y., 379.5 (EST)—1 PM to 2; 5:30 to 8:30.
 WHAD, Milwaukee, Wis., 275 (CST)—11 AM to 12:30 PM; 2 to 10:30.
 WHAS, Louisville, Ky., 399.8 (CST)—4 PM to 5; 7:30 to 9.
 WHN, New York City, 360 (ESTDS)—2:15 PM to 5; 6:30 to 12.
 WHO, Des Moines, Iowa, 526 (CST)—12:15 PM to 1:30; 7:30 to 9; 11:15 to 12.
 WHT, Chicago, Ill., 400 (CSTDS)—11 AM to 2 PM; 7 to 8:30; 10:30 to 1 AM.
 WIP, Philadelphia, Pa., 508.2 (ESTDS)—7 AM to 8; 1 PM to 2; 3 to 8.
 WJZ, New York City, 455 (ESTDS)—10 AM to 11; 1 PM to 2; 4 to 5:30; 6 to 6:30; 7 to 11.
 WKRC, Cincinnati, O., 326 (EST)—8 PM to 10.
 WLIT, Philadelphia, Pa., 395 (EST)—12:02 PM to 1; 2 to 3; 4:30 to 6; 7:30 to 11:30.
 WLW, Cincinnati, O., 422.3 (EST)—10:45 AM to 12:15 PM; 1:30 to 2:30; 3 to 5; 6 to 10.
 WMAC, Lockport, N. Y., 265.5 (EST)—8 PM to 12.
 WMCA, New York City, 341 (ESTDS)—3 PM to 5; 6:30 to 7:45; 8 to 12.
 WNYC, New York City, 526 (ESTDS)—3:15 PM to 4:15; 6:20 to 11.
 WOAW, Omaha, Neb., 526 (CST)—12:30 PM to 1:30; 5:45 to 10:30.
 WOC, Davenport, Iowa, 484 (CST)—12:57 PM to 2; 3 to 3:30; 5:45 to 6.
 WOO, Philadelphia, Pa., 508.2 (ESTDS)—11 AM to 1 PM; 4:40 to 6; 7:30 to 11.
 WOR, Newark, N. J., 405 (ESTDS)—6:45 AM to 7:45; 2:30 to 4; 6:15 to 11:30.
 WPAK, Fargo, N. D., 283 (CST)—7:30 PM to 9.
 WPG, Atlantic City, N. J., 299.8 (ESTDS)—7 PM to 11.
 WQJ, Chicago, Ill., 448 (CST)—11 AM to 12 M; 3 PM to 4.
 WRC, Washington, D. C., 469 (EST)—1 PM to 2; 4 to 6.
 WRNY, New York City, 258.5 (ESTDS)—11:59 AM to 2 PM; 7:59 to 11.



A NEW STUDIO for the former WSB, Newark, N. J., was opened in New York City, when the station became WGCP, 500 watts, 252 meters. The location is Grand Central Palace. The microphone is hooked up to live wires, as the transmission is from Newark. Helen Dickinson is singing. (Kadel & Herbert.)

WWJ, Detroit, Mich., 352.7 (EST)—8 AM to 8:30; 9:30 to 10:30; 11:55 to 1:30 PM; 3 to 4; 6 to 10.
 KDKA, Pittsburgh, Pa., 309 (EST)—6 AM to 7; 9:45 to 12:15 PM; 2:30 to 3:20; 5:30 to 10.
 KEAE, State College of Wash., 348.6 (PST)—7:30 PM to 9.
 KFI, Los Angeles, Cal., 467 (PST)—5 PM to 11.
 KFKX, Hastings, Neb., 288.3 (CST)—12:30 PM to 1:30; 5:15 to 6:15; 9:30 to 12:30.
 KFNF, Shenandoah, Iowa, 266 (CST)—12:15 PM to 1:15; 3 to 4; 6:30 to 10.
 KFOA, Seattle, Wash., 455 (PST)—12:45 PM to 1:30; 4 to 5:15; 6 to 10.
 KGO, Oakland, Cal., 361.2 (PST)—9 AM to 10:30; 11:30 AM to 1 PM; 1:30 to 6; 6:45 to 7; 8 to 1 AM.
 KGW, Portland, Oregon, 491.5 (PST)—11:30 AM to 1:30; 5 to 8.
 KHJ, Los Angeles, Cal., 405.2 (PST)—7 AM to 7:15; 12 M to 1:30 PM; 5:30 to 10.
 KNX, Hollywood, Cal., 337 (PST)—12 M to 1 PM; 4 to 5; 6:30 to 12.
 KOB, State College of New Mexico, 348.6 (MST)—11:55 AM to 12:30 PM; 7:30 to 8:30; 9:55 to 10:10.
 KPO, San Francisco, Cal., 429 (PST)—10:30 AM to 12 M; 1 PM to 2; 2:30 to 3:30; 4:30 to 10.
 KSD, St. Louis, Mo., 545.1 (CST)—7:30 PM to 10.
 KTHS, Hot Springs, Ark., 374.8 (CST)—12:30 PM to 1; 8:30 to 10.
 KYW, Chicago, Ill., 536 (CSTDS)—6:30 AM to 7:30; 10:55 to 1 PM; 2:15 to 3:30; 6:02 to 7.

TUESDAY, JUNE 30

WAAM, Newark, N. J., 263 (ESTDS)—11 AM to 12 M; 7 PM to 11.
 WAHG, Richmond Hill, N. Y., 316 (ESTDS)—12 PM to 1:05 AM.
 WAMB, Minneapolis, Minn., 243.8 (CST)—12 M to 1 PM; 10 to 12.
 WBBM, Chicago, Ill., 226 (CST)—8 PM to 12.
 WBOQ, Richmond Hill, N. Y., 286 (ESTDS)—3:30 PM to 6:30.
 WBZ, Springfield, Mass., 333.1 (ESTDS)—6 PM to 11.
 WCAE, Pittsburgh, Pa., 461.3 (ESTDS)—12:30 PM to 1:30; 4:30 to 5:30; 6:30 to 11.
 WCCO, St. Paul and Minneapolis, Minn., 416.4 (CST)—9:30 AM to 12 M; 1:30 PM to 4; 5:30 to 10.
 WDAF, Kansas City, Kansas, 365.6 (CST)—3:30 PM to 7; 11:45 to 1 AM.
 WEAJ, New York City, 492 (ESTDS)—6:45 AM to 7:45; 11 to 12 M; 4 PM to 5; 6 to 12.
 WEAR, Cleveland, O., 390 (EST)—11:30 AM to 12:10 PM; 7 to 10; 10 to 11.
 WEEL, Boston, Mass., 476 (ESTDS)—6:45 AM to 8; 1 PM to 2; 6:30 to 10.
 WFAA, Dallas, Texas, 475.9 (CST)—10:30 AM to 11:30; 12:30 PM to 1; 2:30 to 6; 6:45 to 7; 8:30 to 9:30; 11 to 12.
 WFBH, New York City, 272.6 (ESTDS)—2 PM to 6:30; 11:30 to 12:30 AM.
 WGBS, New York City, 316 (ESTDS)—10 AM to 11; 1:30 PM to 3; 6 to 11:30.
 WGES, Chicago, Ill., 250 (CSTDS)—5 PM to 8; 10:30 to 1 AM.
 WGN, Chicago, Ill., 370 (CST)—9:31 AM to 3:30 PM; 5:30 to 11:30.
 WGR, Buffalo, N. Y., 319 (ESTDS)—11 AM to 12:45 PM; 7:30 to 11.
 WGY, Schenectady, N. Y., 379.5 (EST)—11 PM to 2:30; 5:20 to 7:30; 9 to 11:30.
 WHAD, Milwaukee, Wis., 275 (CST)—11 AM to 11:30; 6 PM to 8.
 WHAS, Louisville, Ky., 399.8 (CST)—4 PM to 5; 7:30 to 9.
 WHN, New York City, 360 (ESTDS)—12:30 PM to 1; 2:15 to 3:15; 4 to 5:30; 7:30 to 10:45; 11:30 to 12:30 AM.
 WHO, Des Moines, Iowa, 526 (CST)—12:15 PM to 1:30; 7:30 to 9; 11 to 12.

WHT, Chicago, Ill., 400 (CSTDS)—11 AM to 2 PM; 7 to 8:30; 10:30 to 1 AM.
 WIP, Philadelphia, Pa., 508.2 (ESTDS)—7 AM to 8; 1 PM to 2; 3 to 4:50; 6 to 11.
 WJZ, New York City, 405 (ESTDS)—7:30 PM to 1:30.
 WJZ, New York City, 455 (ESTDS)—10 AM to 11; 1 PM to 2; 4 to 6; 7 to 11.
 WKRC, Cincinnati, O., 326 (EST)—8 PM to 12.
 WLIT, Philadelphia, Pa., 395 (EST)—11 AM to 12:30 PM; 2 to 3; 4:30 to 7.
 WLW, Cincinnati, O., 422.3 (EST)—10:45 AM to 1 PM; 1:30 to 2:30; 3 to 5; 6 to 11.
 WMCA, New York City, 341 (ESTDS)—3 PM to 4:15; 5 to 7:15; 7:30 to 10:30; 11 to 12.
 WNYC, New York City, 526 (ESTDS)—3:45 PM to 5; 6:50 to 11.
 WOAW, Omaha, Neb., 526 (CST)—12:30 PM to 1:30; 5:45 to 11.
 WOC, Davenport, Iowa, 484 (CST)—12:57 PM to 2; 3 to 3:30; 5:45 to 10.
 WOO, Philadelphia, Pa., 508.2 (ESTDS)—11 AM to 1 PM; 4:40 to 5; 10:55 to 11:02.
 WOR, Newark, N. J., 405 (ESTDS)—6:45 AM to 7:45; 2:30 PM to 4; 6:15 to 7:30.
 WPG, Atlantic City, N. J., 299.8 (ESTDS)—7 PM to 11.
 WQJ, Chicago, Ill., 448 (CST)—11 AM to 12 M; 3 PM to 4; 7 to 8; 10 to 2 AM.
 WRC, Washington, D. C., 469 (EST)—4:30 PM to 5:30; 6:45 to 11.
 WRNY, New York City, 258.5 (ESTDS)—11:59 AM to 2 PM; 4:30 to 5; 8 to 11.
 WWJ, Detroit, Mich., 352.7 (EST)—8 AM to 8:30; 9:30 to 10:30; 11:55 to 1:30 PM; 3 to 4; 6 to 10.
 KDKA, Pittsburgh, Pa., 309 (EST)—9:45 PM to 12 M; 1:30 PM to 3:20; 5:30 to 10:45.
 KFI, Los Angeles, Cal., 467 (PST)—5 PM to 11.
 KFKX, Hastings, Neb., 288.3 (CST)—12:30 PM to 1:30; 5:15 to 6:15; 9:30 to 12:30.
 KFOA, Seattle, Wash., 455 (PST)—12:30 PM to 1:30; 4 to 5:15; 6 to 11.
 KGO, Oakland, Cal., 361.2 (PST)—11:30 AM to 1 PM; 1:30 to 3; 4 to 6:45; 8 to 1 AM.
 KGW, Portland, Oregon, 491.5 (PST)—11:30 AM to 1:30 PM; 5 to 11.
 KHJ, Los Angeles, Cal., 405.2 (PST)—7 AM to 7:15; 12 M to 1:30 PM; 5:30 to 11.
 KNX, Hollywood, Cal., 337 (PST)—9 AM to 10; 1 PM to 2; 4 to 5; 6:30 to 12.
 KPO, San Francisco, Cal., 429 (PST)—7 AM to 7:45; 10 to 12 M; 1 PM to 2; 3:30 to 11.
 KSD, St. Louis, Mo., 541.1 (CST)—6 PM to 7.
 KTHS, Hot Springs, Ark., 374.8 (CST)—12:30 PM to 1; 8:30 to 10:30.
 KYW, Chicago, Ill., 536 (CSTDS)—6:30 AM to 7:30; 10:30 to 1 PM; 2:15 to 4; 6:02 to 11:30.
 CNRA, Moncton, New Brunswick, Canada, 313 (EST)—9:30 PM to 11.
 CNRR, Regina, Saskatchewan, Canada, 8 PM to 11.

WEDNESDAY, JULY 1

WAAM, Newark, N. J., 263 (ESTDS)—11 AM to 12 M; 7 PM to 11.
 WAHG, Richmond Hill, N. Y., 316 (ESTDS)—12 M to 1:05 PM; 8 to 12.
 WAMB, Minneapolis, Minn., 243.8 (CST)—12 M to 1 PM; 10 to 12.
 WBBM, Chicago, Ill., 226 (CST)—8 PM to 10.
 WBZ, Springfield, Mass., 333.1 (ESTDS)—6 PM to 11.
 WCAE, Pittsburgh, Pa., 461.3 (ESTDS)—12:30 PM to 1:30; 4:30 to 5:30; 6:30 to 11.
 WCCO, St. Paul and Minneapolis, Minn., 416.4 (CST)—9:30 AM to 12 M; 1:30 to 4; 5:30 to 11.
 WDAF, Kansas City, Kansas, 365.6 (CST)—3:30 PM to 7; 8 to 9:15; 11:45 to 1 AM.
 WEAJ, New York City, 492 (ESTDS)—6:45 AM to 7:45; 11 to 12 M; 4 PM to 5; 6 to 12.
 WEOA, Ohio State University, 293.9 (EST)—8 PM to 10.
 WEAR, Cleveland, O., 390 (EST)—11:30 AM to 12:10 PM; 3:30 to 4:10; 6:45 to 7:45.
 WEEL, Boston, Mass., 476 (ESTDS)—6:45 AM to 8; 3 PM to 4; 5:30 to 10.
 WEMC, Berrien Springs, Mich., 286 (CST)—8:15 PM to 11.
 WFAA, Dallas, Texas, 475.9 (CST)—10:30 AM to 11:30; 12:30 PM to 1.
 WFBH, New York City, 272.6 (ESTDS)—2 PM to 7:30; 12 M to 1 AM.
 WGCP, New York City, 252 (ESTDS)—8 PM to 11.
 WGES, Chicago, Ill., 250 (CSTDS)—5 PM to 7; 10:30 to 1 AM.
 WGBS, New York City, 316 (ESTDS)—10 AM to 11 PM; 1:30 to 4; 6 to 7.
 WGN, Chicago, Ill., 370 (CST)—9:31 AM to 3:30 PM; 5:30 to 11:30.
 WGR, Buffalo, N. Y., 319 (ESTDS)—12 M to 12:45 PM; 2:30 to 4:30; 6:30 to 11.
 WGY, Schenectady, N. Y., 379.5 (CST)—5:30 PM to 7:30.
 WHAD, Milwaukee, Wis., 275 (CST)—11 AM to 11:30; 4 PM to 5; 6 to 10; 11:30 to 12:30 AM.
 WHAS, Louisville, Ky., 399.8 (CST)—4 PM to 5; 7:30 to 9.
 WHN, New York City, 360 (ESTDS)—2:15 PM to 5:30; 7:30 to 11; 11:30 to 12:30 AM.
 WHO, Des Moines, Iowa, 526 (CST)—12:15 PM to 1:30; 6:30 to 12 M.
 WHT, Chicago, Ill., 238 and 400 (CSTDS)—11 AM to 1 PM (238 meters); 7 to 8:30 (400 meters); 8:45 to 10:05 (238 meters); 10:30 to 1 AM (400 meters).
 WHT, Chicago, Ill., 400 (CSTDS)—11 AM to 2 PM; 7 to 8:30; 10:30 to 1 AM.
 WIP, Philadelphia, Pa., 508 (ESTDS)—7 AM to 8; 10:20 to 11; 1 PM to 2; 3 to 4; 6 to 8.
 WJZ, New York City, 455 (ESTDS)—10 AM to 11; 1 PM to 2; 4 to 6; 7 to 11:30.
 WKRC, Cincinnati, Ohio, 326 (EST)—8 PM to 10.
 WLIT, Philadelphia, Pa., 395 (EST)—12:02 PM to 12:30; 2 to 3; 4:30 to 6; 7:30 to 9.

WLW, Cincinnati, O., 422.3 (EST)—10:45 AM to 12:15 PM; 1:30 to 2:30; 3 to 5; 6 to 11.
 WMCA, New York City, 341 (ESTDS)—3 PM to 3:45; 4 to 5; 6:30 to 12.
 WNYC, New York City, 526 (ESTDS)—6:30 PM to 11.
 WOC, Davenport, Iowa, 484 (CST)—12:57 PM to 2; 3 to 3:30; 4 to 7:05; 9 to 11.
 WOR, Newark, N. J., 405 (ESTDS)—6:45 AM to 7:45; 2:30 PM to 4; 6:15 to 12 M.
 WPAK, Fargo, N. D., 283 (CST)—7:30 PM to 9.
 WQJ, Chicago, Ill., 448 (CST)—11 AM to 12 M; 3 PM to 4; 7 to 8; 10 to 2 AM.
 WRC, Washington, D. C., 469 (EST)—1 PM to 2; 4 to 6:30.
 WRNY, New York City, 258.5 (ESTDS)—11:59 AM to 2 PM; 7:59 to 9:55.
 WWJ, Detroit, Mich., 352.7 (EST)—8 AM to 8:30; 9:30 to 10:30; 11:55 to 1:30 PM; 3 to 4; 6 to 7; 8 to 10.
 KDKA, Pittsburgh, Pa., 309 (EST)—6 AM to 7; 9:45 to 12:15 PM; 2:30 to 3:20; 5:30 to 11.
 KFAE, State College of Wash., 348.6 (PST)—7:30 PM to 9.
 KFI, Los Angeles, Cal., 467 (PST)—5 PM to 11.
 KFKX, Hastings, Neb., 288.3 (CST)—12:30 PM to 1:30; 5:15 to 6:15; 9:30 to 12:30.
 KFNF, Shenandoah, Iowa, 266 (CST)—12:15 PM to 1:15; 3 to 4; 6:30 to 10.
 KFOA, Seattle, Wash., 455 (PST)—12:30 PM to 1:30; 4 to 5:15; 6 to 10.
 KGO, Oakland, Cal., 361.2 (PST)—11:30 AM to 1 PM; 1:30 to 2:30; 3 to 6:45.
 KGW, Portland, Oregon, 491.5 (PST)—11:30 AM to 1:30 PM; 5 to 10.
 KHJ, Los Angeles, Cal., 405.2 (PST)—7 AM to 7:15; 12 M to 1:30 PM; 5:30 to 12.
 KNX, Hollywood, Cal., 337 (PST)—1 PM to 2; 7 to 12.
 KOB, State College of New Mexico, 348.6 (MST)—11:55 AM to 12:30 PM; 7:30 to 8:30; 9:55 to 10:10.
 KPO, San Francisco, Cal., 429 (PST)—7 AM to 8; 10:30 to 12 M; 1 PM to 2; 4:30 to 11.
 KSD, St. Louis, Mo., 545.1 (CST)—7 PM to 10.
 KTHS, Hot Springs, Ark., 374.8 (CST)—8:30 PM to 10.
 KYW, Chicago, Ill., 536 (CSTDS)—6:30 AM to 7:30; 10:55 to 1 PM; 2:15 to 4; 6:02 to 11:30.
 PWX, Havana, Cuba, 400 (EST)—8:30 PM to 11:30.
 CNRO, Ottawa, Ontario, Canada, 435 (EST)—7 PM to 11.

THURSDAY, JULY 2

WAAM, Newark, N. J., 263 (ESTDS)—11 AM to 12 M; 7 PM to 11.
 WAHG, Richmond Hill, N. Y., 316 (EST)—12 PM to 1:05.
 WAMB, Minneapolis, Minn., 243.8 (CST)—12 M to 1 PM; 10 to 12 M.
 WBBM, Chicago, Ill., 226 (CST)—8 PM to 10.
 WBOQ, Richmond Hill, N. Y., 236 (ESTDS)—3:30 PM to 6:30.
 WBZ, Springfield, Mass., 333.1 (ESTDS)—6 PM to 11:45.
 WCAE, Pittsburgh, Pa., 461.3 (CSTDS)—12:30 PM to 1:30; 4:30 to 5:30; 6:30 to 11.
 WCBD, Zion, Ill., 344.6 (CST)—8 PM to 10.
 WCCO, St. Paul and Minneapolis, Minn., 416.4 (CST)—9:30 AM to 12 M; 1:30 PM to 4; 5:30 to 10.
 WEA, New York City, 492 (ESTDS)—6:45 AM to 7:45; 11 to 12 M; 4 PM to 5; 6 to 12.
 WEAR, Cleveland, O., 390 (EST)—10:30 AM to 12:10 PM; 3:30 to 4:15; 7 to 11.
 WEEI, Boston, Mass., 476 (ESTDS)—6:45 AM to 7:45; 1 PM to 2; 2:30 to 10.
 WFAA, Dallas, Texas, 432 (CST)—10:30 AM to 11:30; 12:30 PM to 1; 2:30 to 6; 6:45 to 7; 8:30 to 9:30; 11 to 1 AM.
 WFBH, New York City, 272.6 (ESTDS)—2 PM to 7:30.
 WGBS, New York City, 316 (ESTDS)—10 AM to 11; 1:30 PM to 4; 6 to 7:30.
 WGES, Chicago, Ill., 250 (CSTDS)—5 PM to 8; 10:30 to 1 AM.
 WGN, Chicago, Ill., 370 (CST)—9:31 AM to 3:30 PM; 5:30 to 11:30.
 WGR, Buffalo, N. Y., 319 (ESTDS)—12 M to 12:45 PM; 2 to 4; 7:30 to 11.
 WHAD, Milwaukee, Wis., 275 (CST)—11 AM to 11:30; 6 PM to 7:15; 8:30 to 11.
 WHAS, Louisville, Ky., 399.8 (CST)—4 PM to 5; 7:30 to 9.
 WHN, New York City, 360 (ESTDS)—2:15 PM to 5; 7:30 to 11; 11:30 to 12:30 AM.
 WHO, Des Moines, Iowa, 526 (CST)—7:30 PM to 9; 11 to 12.
 WHT, Chicago, Ill., 400 (CSTDS)—11 AM to 2 PM; 7 to 8:30; 10:30 to 1 AM.
 WJY, New York City, 405 (ESTDS)—7:30 PM to 11:30.
 WJZ, New York City, 455 (ESTDS)—10 AM to 11 PM; 1 to 2; 4 to 6; 7 to 12 M.
 WLIT, Philadelphia, Pa., 395 (EST)—12:02 PM to 12:30; 2 to 3; 4:30 to 6; 8:30 to 9.
 WLW, Cincinnati, O., 422.3 (EST)—10:40 AM to 12:15 PM; 1:30 to 5; 6 to 8; 10 to 11.
 WMAK, Lockport, N. Y., 265.5 (EST)—11 PM to 1 AM.
 WMCA, New York City, 341 (ESTDS)—3 PM to 4:45; 8 to 12.
 WNYC, New York City, 526 (ESTDS)—3:15 PM to 4:15; 6:50 to 11.
 WOAW, Omaha, Neb., 526 (CST)—12:30 PM to 1:30; 5:45 to 11.
 WOC, Davenport, Iowa, 484 (CST)—12:57 AM to 2 PM; 3 to 3:30; 4 to 7:10; 8 to 9.
 WOR, Newark, N. J., 405 (ESTDS)—6:45 AM to 7:45; 2:30 PM to 4; 6:15 to 7.
 WPG, Atlantic City, N. J., 299.8 (ESTDS)—7 PM to 11.
 WQJ, Chicago, Ill., 448 (CST)—11 AM to 12 M; 3 PM to 4; 7 to 8; 10 to 2 AM.
 WRC, Washington, D. C., 469 (EST)—1 PM to 2; 4 to 6:30.

WRNY, New York City, 258.5 (ESTDS)—11:59 AM to 2 PM; 7:59 to 10.
 WWJ, Detroit, Mich., 352.7 (EST)—8 AM to 8:30; 9:30 to 10:30; 11:55 to 1:30; 3 to 4; 6 to 7; 8 to 9.
 KDKA, Pittsburgh, Pa., 309 (EST)—9:45 AM to 12:15 PM; 2:30 to 3:20; 5:30 to 10:15.
 KFAE, State College of Washington, 348.6 (PST)—7:30 PM to 9.
 KFI, Los Angeles, Cal., 467 (PST)—5 PM to 11.
 KFKX, Hastings, Neb., 288.3 (CST)—12:30 PM to 1:30; 5:15 to 6:15; 9:30 to 12:30.
 KFNF, Shenandoah, Iowa, 266 (CST)—12:15 to 1:15 PM; 3 to 4; 6:30 to 10.
 KFOA, Seattle, Wash., 455 (PST)—12:30 PM to 1:30; 4 to 5:15; 6 to 7.
 KGO, Oakland, Cal., 361.2 (PST)—11:30 AM to 1 PM; 1:30 to 3; 4 to 6:45; 7:15 to 10.
 KGW, Portland, Oregon, 491.5 (PST)—11:30 AM to 1:30 PM; 5 to 11.
 KHJ, Los Angeles, Cal., 405.2 (PST)—7 AM to 7:15; 12 M to 1:30; 5:30 to 11:30.
 KNX, Hollywood, Cal., 337 (PST)—11 AM to 12:05 PM; 4 to 5; 6 to 12.
 KPO, San Francisco, Cal., 429 (PST)—7 AM to 8; 10:30 to 12 M; 1 PM to 2; 3:30 to 11.
 KSD, St. Louis, Mo., 595.1 (CST)—7:30 PM to 9.
 KYW, Chicago, 536 (CSTDS)—6:30 AM to 7:30; 10:55 to 1 PM; 2:25 to 2:30; 6:02 to 11.
 CNRC, Calgary, Canada, 430 (MST)—7 PM to 10.
 CNRM, Montreal, Canada, 411 (EST)—8:30 PM to 10:30.
 CNRW, Winnipeg, Canada, 384.4 (CST)—8 PM to 10.

THE 1-A PORTABLE, 1925 Spring Model, a 2-Tube Set of Great DX Powers. Two controls. Described by Herbert E. Hayden in RADIO WORLD, issues of March 28, April 4 and April 11, with trouble-shooting article in April 18 issue. Profusely illustrated, including templates. Send 60c, get all four copies. Address Circulation Manager, RADIO WORLD, 1493 Broadway, New York City.

ONE TUBE MORE FOR QUALITY; The 3-Tube Neutrodyne Using the Reflex Plan; The Short-Wave Receiver Reinartz Will Use in Arctic—all these appeared in RADIO WORLD, dated May 16, 15c. per copy, or start your subscription with this number, RADIO WORLD, 1493 Broadway, New York City.

THE SHORT-WAVE RECEIVER REINARTZ WILL USE IN ARCTIC. Full wiring directions. Send 15c for May 16 issue, RADIO WORLD, 1493 Broadway, New York City.

A SIMPLE 1-TUBE DX SET FOR THE NOVICE, by Percy Warren. Send 15c for May 23 issue, RADIO WORLD.



MEET Smith, of England. Plenty definite enough, that! Anybody with a trans-Atlantic set knows Smith as the world's famous announcer, Headquarters, London, but he's on a visit here, to try to learn something about American methods (and maybe laugh at them, during dinner stories, when he gets home). And maybe not. The Smiths are the nicest set of people. (International Newsreel.)

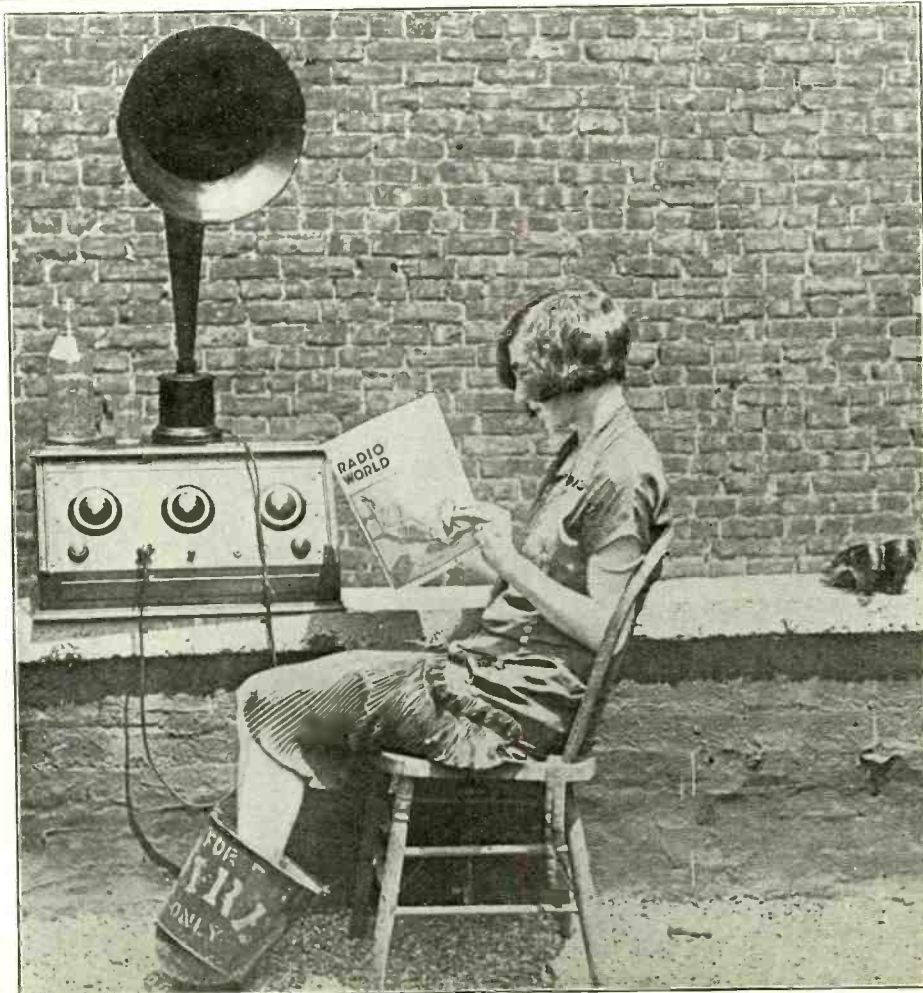

WHAT'S WRONG HERE?—One hot day Hortense Unger went on the roof to keep cool, consulting RADIO WORLD'S key to the air for most refreshing program. So far, so good. But—what about the temperature on the roof, in the sun's ocean of heat? Answer: Hence the water pail. (Foto Topics.)

Rheostat Troubles Avoided

Tuning Aerial

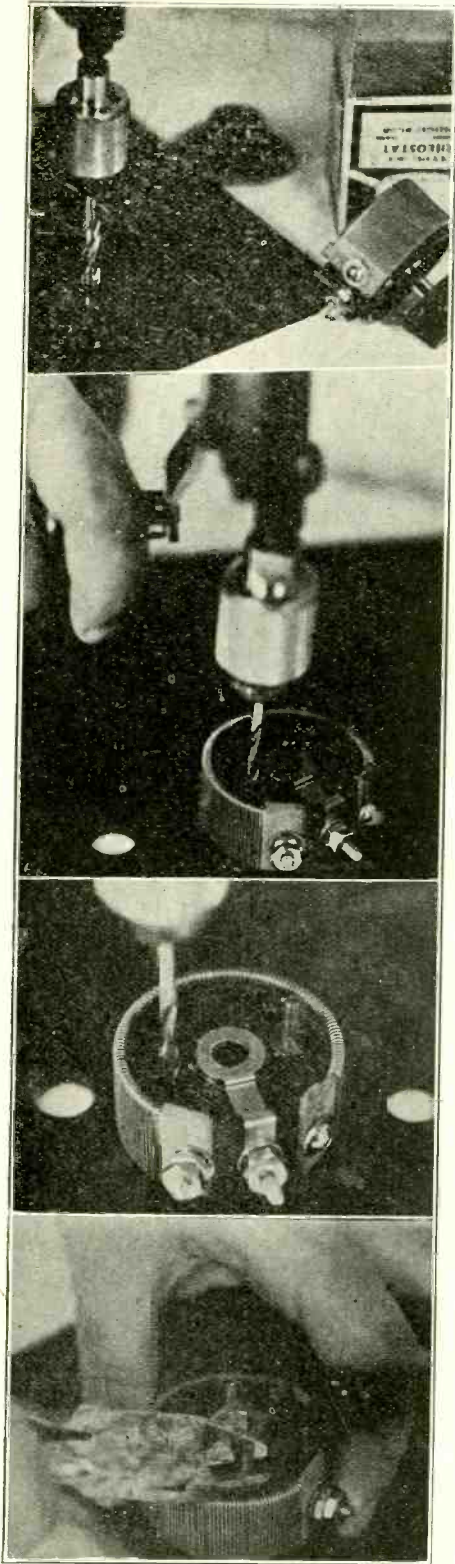

FIG. 1 (top), drill panel in usual manner with 1/4" drill. Fig. 2, place shaft through panel and rheostat and drill one hole for mounting screw. Fig. 3, place mounting screw in hole just drilled and after fastening with small nut, drill the other hole in the same manner. Fig. 4, if after fastening things up it is found the screws are a little long and interfere with the passage of the rheostat contact arms, cut the protrusions off with a pair of diagonal cutting pliers.

RHEOSTATIC

How disagreeable Mr. Resistance must be, offering opposition to everything!

* * *

A rheostat is as good as it works, but seldom as good as it looks. Often the worse it looks, the better it works.

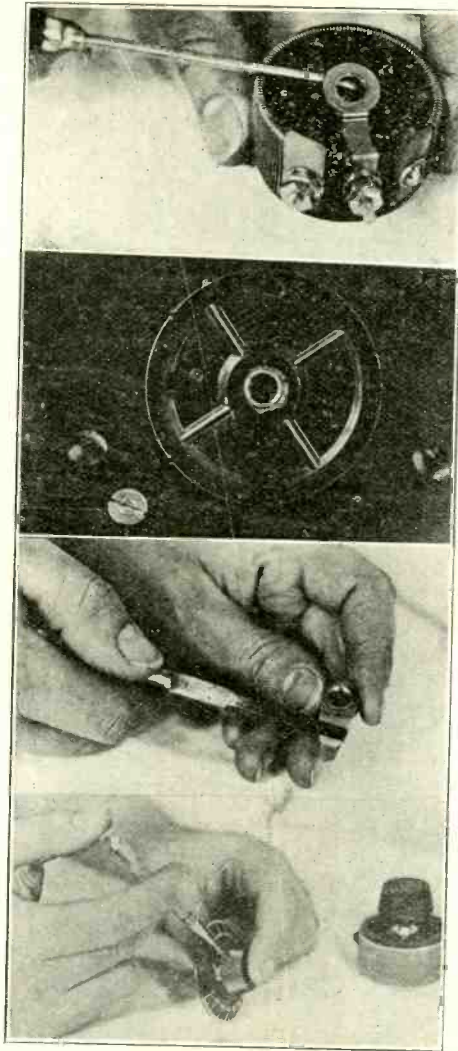
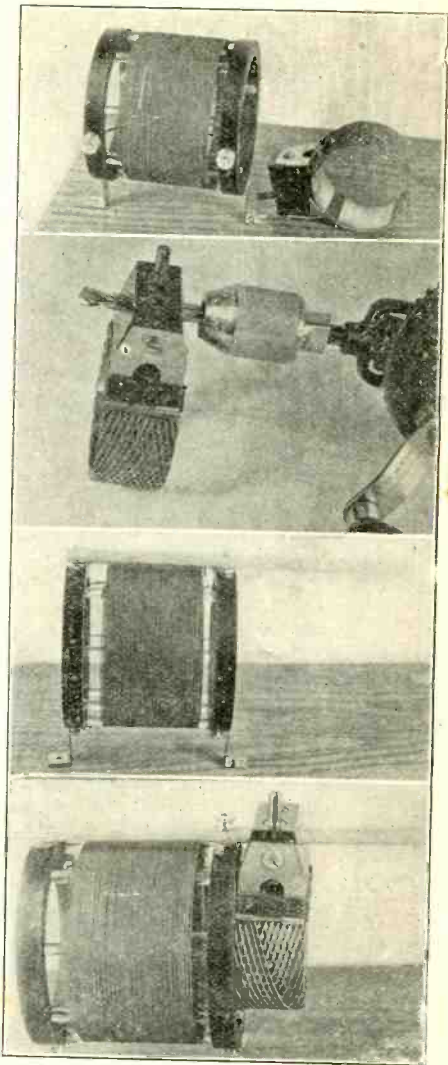
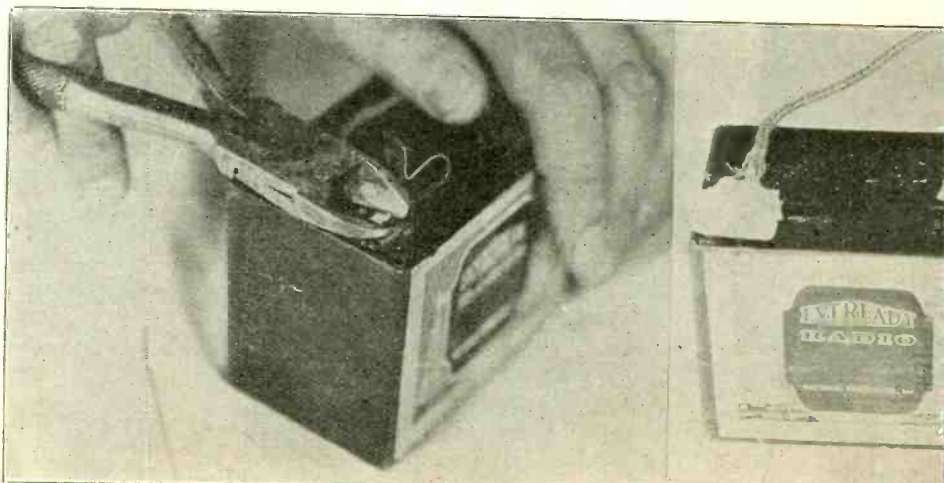

FIG. 5 (top), bend up the contact spring before assembling the rheostat. This is to make a good contact. Fig. 6, countersink the heads of screws on the front side of panel as the dial frequently cannot pass if the screw head protrudes. Fig. 7, also bend down the little contact arm before placing on shaft. In this way a good contact is maintained, and one of the worst things that can happen to your set is loose contacts. Fig. 8, when the rheostat dial is mounted use a small jeweler's screwdriver in tightening the set-screw. This avoids breaking the dial to pieces where it has been drilled to receive the screw. If the rheostat arm still does not move smoothly over the resistance wire, push the center of the arm towards the resistance wire. (Hayden.)



VERY OFTEN it is found a set will not respond to the high wavelengths. The usual method of boosting the wavelength is by shunting the coil with a fixed or variable condenser, but suppose we have no condenser, instead we have a honeycomb coil and desire to put it to use. However, we find that we cannot mount the coil. Take a look at the photographs and see how easily it is done. Through a dowel drill a small hole to accommodate the coil binding post. Now take the honeycomb coil and exactly in the center of its mount drill a hole, large enough for the dowel shaft to fit (usually 1/4"). The honeycomb may be conductively coupled to the secondary, and varied. For another form of tuned primary, connect aerial and ground to the HC, and grid and filament to the other coil. (Hayden.)



DURING SUMMER there are many portable sets being put into use and one of the chief difficulties is the cabinet, due mostly to the clips. First nip the posts off with pliers, making sure that the connection. The long leads from the set are then soldered to these small tips and covered over with tape. The picture at left shows the clips being nipped off and the one at right how batteries look

A Brisk Brush

Sports Reported on Short Waves

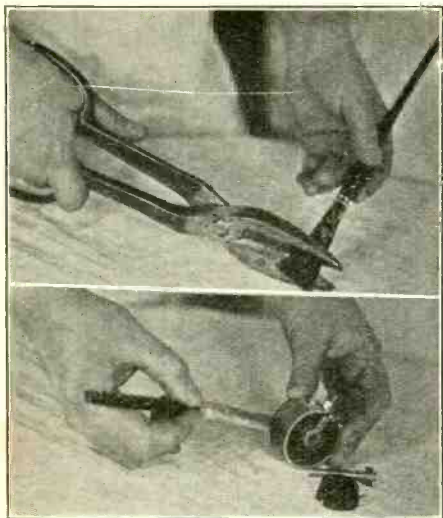

A BRUSH is only as good as it is stiff for radio use, so if you have a brush that behaves like a downy willow, give it a boyish bob. That will produce a bristling effect which will enable you to clean those radio parts as you had intended to do since 1922. (Hayden.)

Girls Will Be Fans



A PORTABLE is standard equipment at the Kiltredge Club for B. & P. Women, Upper Twin Lakes, N. Y. (near Bear Mountain). Oh, yes, it means "Best and Prettiest," or "Business and Professional," whichever you prefer. (Foto Topics.)

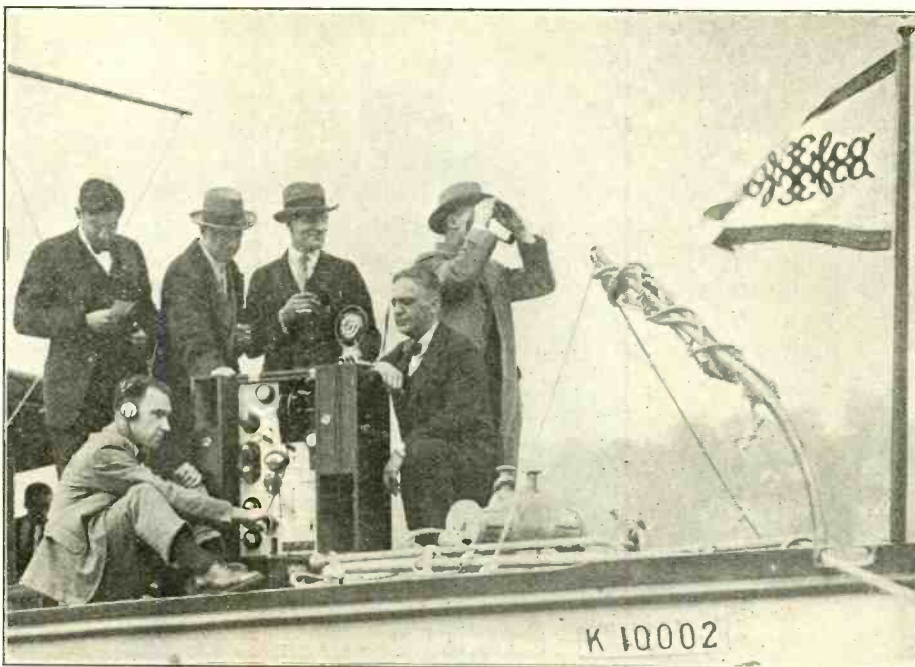

MAJOR J. ANDREW WHITE, at the microphone of a short-wave portable transmitter of WJZ, describing a yacht race from a motor boat. This is picked up at WJZ and retransmitted on their regular wave of 455 meters. This type of retransmitting is becoming very popular and is a very economical and excellent way of retransmission, as the bother of laying land lines is done away with and there are no land line noises as trouble sources.

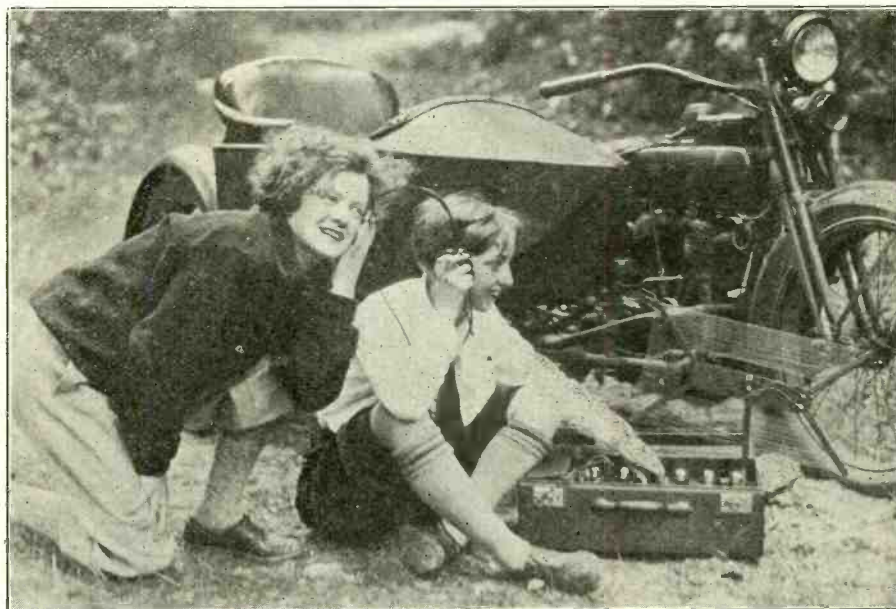

THE BOY tuning in the set is a girl—one of the pair who rest and hear music by the good graces of the portable. Rosalie Quinn and Gertrude Jolin are the pair. (Foto Topics.)



difficulties is that the B batteries do not fit in there is enough room to make a soldered connection with pieces of adhesive tape, to prevent any when they are completely wired up. (Hayden.)



When on the lake with your portable you will find others crowding 'round. Maybe those not so near can't hear so distinctly. "The best is none too often on sunny lakes," as Nero said, just before he stopped fiddling with portables. (Foto Topics.)

THE RADIO UNIVERSITY

A QUESTION and Answer Department conducted by RADIO WORLD for its Readers by its Staff of Experts. Address Letters to The Radio University, RADIO WORLD, 1493 Broadway, New York City.

I HAVE an old variocoupler, a 7-plate variable condenser and a 23-plate condenser. Would you please give me a hookup of a 1-tube regenerative set employing

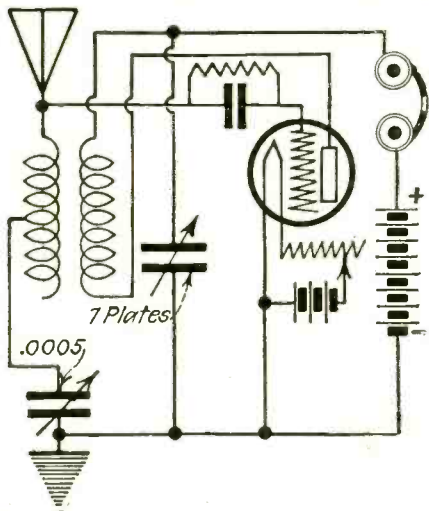

FIG. 157 shows the above diagram of a 1-tube set employing regeneration. A UV200 tube is used for the detector, with 22½ volts on the plate and 6 volts to light the filament. The rheostat is placed in the negative filament lead of the tube and the grid return is to positive A and ground. There is no absolute necessity for the primary of the coupler being tapped. Bring the end of the coil to stator plates of the .0005 mfd. variable condenser. For those who haven't the coupler and wish to build this set, take a tubing 3" in diameter, and wind 10 turns of No. 20 or 22 wire for the primary, on the outside or the stator form. For the rotor or the secondary wind 45 turns on a piece of tubing 2" in diameter, using number 26 DCC wire. This set is a miniature transmitter and great care should be exercised when tuning, otherwise the operator will annoy his neighbors.

the above materials, with the usual accessories.—P. F. Parkins, Long Island City, N. Y.

See Fig 157

WHICH IS the better type of rectifier, the bulb or the vibrating type?—C. S. Garbana, Louisville, Ky.

The bulb type is the better, because it is quieter in operation and is less expensive in the end. The battery also charges better.

WILL you please give me a diagram of the simplest crystal set, employing a vario-

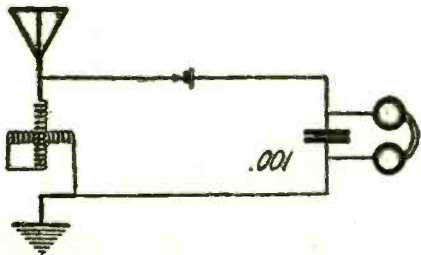

FIG. 158, the simplest crystal receiver, employing a variometer for tuning. This set is not selective nor practical for the exacting conditions today.

meter for the purpose of tuning?—I. O. Katar, Grange, N. D.

See Fig. 158 for the diagram.

I HAVE a 5-tube tuned radio-frequency set, which works great in the city, but when I took it to the mountains I could only get very weak signals. I am not very far away from any stations. Why is this?—Harry Rose, 1493 Broadway, New York City, c/o "Star."

This is due to poor location, due to an "air pocket," iron ore in mountains or trees

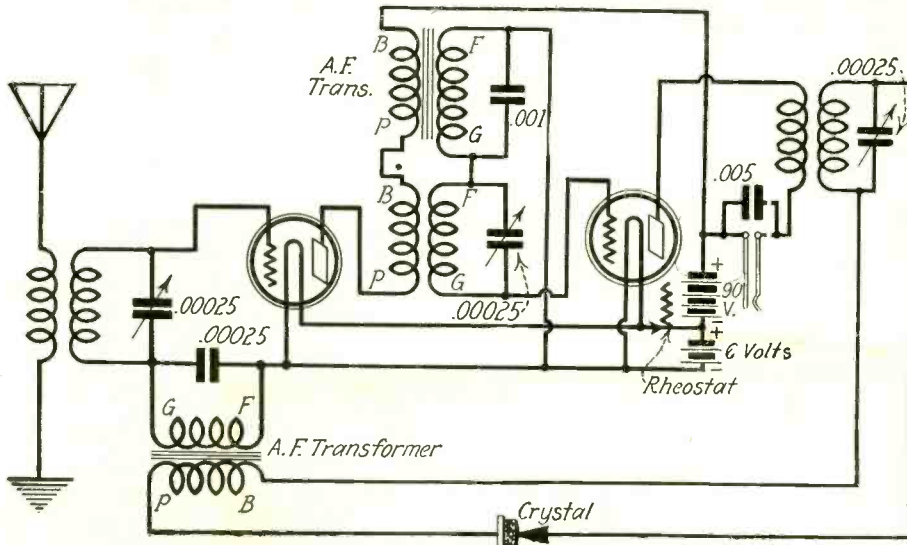

FIG. 159, showing the diagram requested by U. S. Shippman. The antenna coupler is wound on a tubing 3 in. in diameter, primary having 8 turns and the detector coil having 56 turns, using No. 24 DCC. The other RFT have 10 turns on the primary and 42 turns on the secondary, using No. 22 DCC wire and a 3 in. form. The 2 AFT are of the lower ratio type. UV 201A tubes are used, 67½ volts being put on the plates of these tubes. Use a fixed crystal detector for stable reception.

(the dampness of which causes the antenna to be grounded).

I WOULD like to have a diagram of a 2-tube reflex set.—U. S. Shippman, Kenton, Ia.

See Fig. 159 for the diagram.

WHAT is the best insulating material to use for a panel.—H. E. Baydents, Jersey City, N. J.

Hard rubber.

I WOULD like to make a complete study of radio telephony. Could you give me a little data on just what is necessary to learn the same? —H. P. Sanford, Long Beach, Cal.

That a person may have a complete knowledge of radio telephony it is absolutely necessary to have a complete knowledge of electricity and magnetism, and also a basic knowledge of the following data: Direct and alternating currents, mechanics, motors and generators AC and DC, high-frequency alternating currents, electric current action in the vacuum tube as well as in the copper wire; electric waves, theoretical knowledge of the ether; material needed for the receiving and the transmitting of radio signals.

ARE THE Arc transmitters going into oblivion? I have not heard an Arc transmitter for about six months and I am an old commercial operator, who listens nine-tenths of the time to code reception.—M. H. L. Farsna, Bronx, N. Y. C.

Yes, only about 30 ships afloat today have Arc transmitters as they are not very efficient on low waves and therefore necessitate two sets, one for low waves and one for the high waves.

IS THE 5-Tube Neutrodyne with "One Lonely Dial," a good practical, selective set? This set was published in the May 30th issue of RADIO WORLD.—P. T. Linkel, Washington, D. C.

Yes

WOULD IT be possible to use the Perfection Low Loss Super-Coil in the Diamond of the Air? (2) If so would the radio-frequency transformer be the same number of turns primary and secondary as the tuning unit? (3) The ratio of the

super-coil is 15 turns primary and 60 turns secondary, 18 double cotton-covered wire. (4) What size tickler wire is used? (5) What is the number of turns? (6) Could I use a 3" form. (7) In Percy Warren's circuit, May 30, 1925, R F Without Extra Control, can No. 22 DCC wire be used? (8) Would the number of turns be the same?—Roy Douglass, Box 30, Hastings, Mich.

(1) Yes, with .00025 mfd. for CF. (2) Not unless a double condenser is used. (3) O. K. (4) No. 26 SCC., (5) 30 turns on a 2" form, (6) Yes, 26 turns, (7) Yes. (8) Yes.

WHERE can I receive full particulars in regard to the circuit shown on page 10 of the June 6 issue of RADIO WORLD?—Geo. Brugman, Box 31, R. D. Oxford, N. J. See answer to Harold Chute.

IN REFERENCE to the article by Herman Bernard, which was entitled, "A Stroll Down Radio Lane," in June 6 issue of RADIO WORLD, there appeared on the top of the article a diagram, which served for the purpose of illustrating how an absolutely good receiver could be made, but which could be made inefficient by a poor aerial, etc. I would like to build this set and would be pleased if I were given the capacity of the condensers and the constants of the coils to build the same.—Harold Chute, 14 Green St., Eastport, Me.

C1, C2, are both .0005 mfd. variable condensers, C3 is a neutralizing condenser with a variable capacity. Any of the standard makes will do here. C4 is a 1.0 mfd. fixed condenser (this is for by-passing purposes); C5 is a .001 mfd. fixed condenser. For the coils use tubing 3" in diameter. L1, L2, are both wound on the same tubing, L1 has 10 turns, terminate, skip ¼", and wind 45 turns. All this winding is done with No. 22 DCC. L3 has 35 turns of that wire.

I AM building the 3-tube reflex set described by H. E. Wright in RADIO WORLD, May 23. I make no pretensions of being an expert, and need a suggestion on some of the points covered. (1) Will a Remler .0005 variable condenser be O. K., and should each

of the three be the same? (2) What is the resistance of the rheostat? (3) What should be the ratio of each of the audio transformers?—J. D. Haile, 3773 24th St., San Francisco, Cal.

(1) Yes. (2) R. is a 6 ohm rheostat. (3) The ratio isn't of much importance, so long as within limits and the transformers well made. See the article by Herman Bernard in this issue, where he discusses audio transformers.

WOULD YOU please give me all the data on the various kinds of oscillators?—L. U. Mulman, Bordan, S. D.

KINDLY advise me how to construct a wavetrapp that will eliminate the wavelength of 273 meters.—Michael E. Milone, 2583 Third Ave., N. Y. C.

Take a piece of tubing 3" in diameter, and wind 39 turns of No. 22 DCC. Shunt the beginning and the end of the coil with a .0005 mfd. variable condenser. Put this wavetrapp in series with the antenna, or put the coil of the trap in inductive relation to the antenna. See article by Lewis Winner on "Wavemeters Without Buzzers," June 20 issue of RADIO WORLD.

IN "The 3-Tube Neutrodyne, Using the Reflex Plan," May 16 issue of RADIO WORLD, there is a short circuit in the filament circuit, at the point where the end of L3 goes to the top of J1, which makes a circuit to the B plus 90 volts, this in turn going also to R1. Should not a .001 mfd. condenser go in between this place, that is between the end of L3 and R1.—D. C. Bullock, 3040 38th St., Seattle, Wash.

Yes, there is enough resistance in the primaries of the AFT to avoid tube blow-out as published.

FROM the list that follows will you please tell me which is the best for the novice to build: Superdyne, Neutrodyne, Diamond of the Air, Ambassador, Roberts, Browning Drake.—Charles Miller, 100 Vernon Ave., Brooklyn, N. Y.

The Diamond of the Air, Roberts, and Browning Drake are the same fundamentally. The desirability of reflexing, as in the Roberts, is debatable. Build the Diamond of the Air, April 4, 11 and the 18 issues of RADIO WORLD, using a loop for utmost selectivity.

I WOULD like very much to get some data on how to build a set that will receive the Arlington Time Signals direct. There is a local station that interferes with the relayed signals from KDKA, sometimes causing me failure in my attempt to receive signals.—W. C. Robinson, 119 West 1st St., Duluth, Minn.

Put a honeycomb inductance (1250 turns), in series with the antenna.

I HAVE a 1-tube Peanut Set which has given me very satisfactory service, but I would like to have louder signals. Would you please give me the diagram for a 2-stage amplifier?—W. J. Monsees, N. Y. C. See RADIO WORLD, December 6 issue.

WILL a 2-volt storage battery operate two WD12 tubes? (2) What acid is added to a storage battery and how much will I add to this 2-volt battery? (3) I have a coil called Cosmos Low Loss. Could you give me a hook-up to fit same?—Bert Jones, 220 50th St., Brooklyn, N. Y.

(1) Yes. (2) Never add acid to a battery. (3) You do not give enough information about the coil.

I HAVE a Globe single winding coil. Would like to construct the Diamond of the Air. (1) Could I use this Globe single winding coil for the R. F. transformer? It has 44 turns of wire and a tap at the 15th turn. How should I connect it? Should

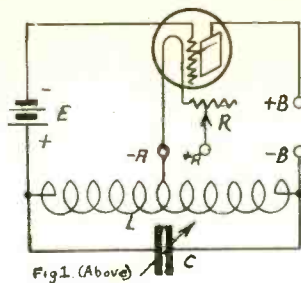

Fig 1 (Above)

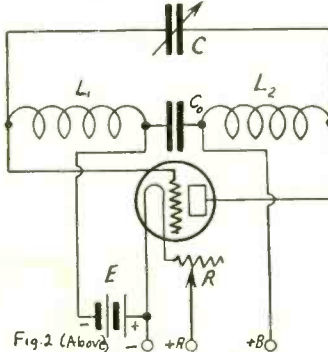

Fig 2 (Above)

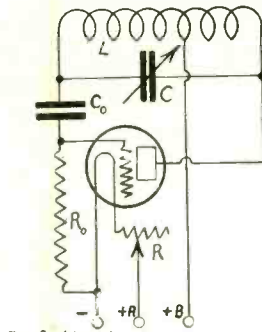

Fig 3 (Above)

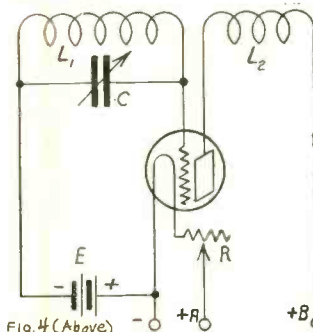

Fig 4 (Above)

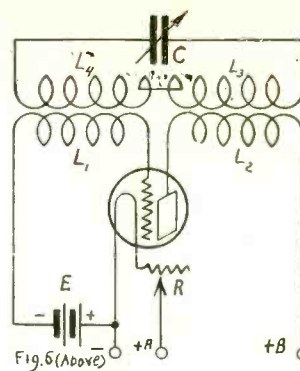

Fig 5 (Above)

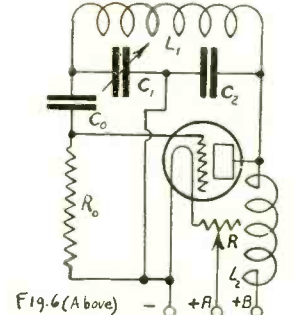

Fig 6 (Above)

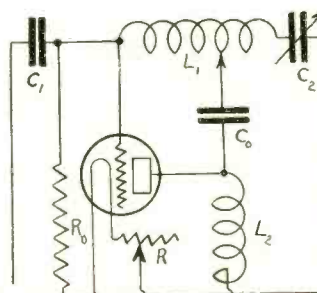

Fig 7

FIG. 154—Fig. 1 (top, left) shows the simplest oscillator, the Hartley Circuit, part of the inductance being in the grid circuit and part in the plate. Fig. 2 (left, second from top) shows the modification of Fig. 1, which permits it to be used as an oscillator in the Super-Heterodyne. A grid leak is used instead of a grid battery in the same circuits (Fig. 3). Fig. 4 shows a common type of oscillator used in the Super-Heterodyne. The Meissner circuit (Fig. 5) is regarded as one of the three fundamental types of oscillator, but it is much like the Hartley circuit. Fig. 6 shows the third fundamental circuit, the Colpitts, using electrostatic coupling. An arrangement enabling variation of coupling, often used, is shown in Fig. 7.

reception be good without R. J. tube on for locals?—Ernest Cosans, 1635 Lewis St., Philadelphia, Pa.

You can use the single winding coil.

Ignore the tap. Wind 10 turns of No. 18 wire around the coil. This is the primary. This 44 turns to tune with a .0005 mfd. condenser.

Join RADIO WORLD'S University Club

and we will enter your name on our subscription and University lists by special number. Put this number on the outside of your envelope addressed to RADIO WORLD (not the enclosed return envelope) and also put it in your queries and the questions will be answered the same day as received.

And Get Free Question and Answer Service for the Coming 52 Weeks.

RADIO WORLD, 1493 Broadway, New York City:

Enclosed find \$6.00 for RADIO WORLD for one year (52 Nos.) and also consider this an application to join RADIO WORLD'S University Club, which gives me free information in your Radio University Department for the coming year, and a number indicating my membership.

Name
Street
City and State

Literature Wanted

THE names of readers of RADIO WORLD who desire literature from radio jobbers and dealers are published in RADIO WORLD on request of the reader. The blank below may be used, or a post card or letter will do instead.
Trade Service Editor,
RADIO WORLD,
1493 Broadway, New York City.

I desire to receive radio literature.

Name

City or town

State

Are you a dealer?

If not who is your dealer?

His Name

His Address

F. M. Chase, Anna, Ill. (Desler).
A. J. England, 5914 Minerva Ave., St. Louis, Mo.
C. M. Meiers, Camp Kearney, Cal. (Dealer).
W. E. Wright, 1319 3d Ave., Roanoke, Va.
Empire Engineers, Inc., Lock Box 1524, Boston, Mass. (Dealer).
California Electric Service Co., 2507 Mason St., Oakland, Cal. (Dealer).
John G. Schoff, Lackawanna, New York.
Lester Weber, Victor, Montora, Canada.
J. T. Crougheaur, Victor, Montora, Canada.
H. E. Myers, 2934 Gettlyer Ave., Pittsburgh, Pa.
S. J. Fitch, Point Torma, San Diego, Cal.
Oscar Wagner, Highland, Ill.
James Toohy, 1932 Annunciator St., New Orleans, La.
Hal De Lamatre, Kimball, O.
H. S. Ricci, Rua, Libero Badaro 189, Cidade de S. Paulo, Brasil, America do Sul.
William Mills, Walnut Ave., Millburn, N. J.
H. Roycott, 1750 Mahan Ave., Bronx, N. Y. C.

JACK WEBBER EXPANDS

JACK WEBBER, well-known to the radio industry, announces that his concern, A. & W. Radio Service, 222 Fulton Street, New York City, will hereafter be known as the Webber Distributing Co., doing business at the same address. Mr. Webber has originated a very catchy slogan for his business, viz., "The House of Many Wires," which is quite apropos to radio and the "live" wires connected with the firm. The Webber Distributing Co., plans big things for Fall, among other things, connections having been made with one of the biggest and most reliable wire houses in the country.

BUSINESS PICKS UP

COOLER weather toward the end of June improved the radio business.

Builder of Silver-Marshall Set Wins First Prize at Show

LOS ANGELES.

DECIDEDLY increased interest among radio enthusiasts has been noted throughout Southern California as an immediate aftermath of the First Annual Amateurs' Radio Show and Contest ever staged on the Pacific Coast. The event was held here for a week in the building of the National Automotive and Electrical School with an attendance said to have broken all radio show records on the Pacific Coast.

Primarily, it was the purpose of this show to foster the interests of the non-professional set builder, and consequently no manufactured sets were on display. The exhibits were confined entirely to parts and accessories, the most prominent displays being of nationally known and advertised product, such as General Radio, Rauland Manufacturing Company, Frost Company, Bremer-Tully, The Dudlo Manufacturing Company, Carter Company, Madera Horns, Harkness parts, Balkite

MUSIC MASTER GETS INTEREST IN WARE RADIO CORPORATION

PAUL WARE, President of the Ware Radio Corporation, and Walter L. Eckhardt, President of the Music Master Corporation, announced the conclusion of a contract between the two companies whereby the Music Master Company purchases the annual output of the Ware factory, which will be marketed under the trade name "Music Master Ware."

William T. Smith, Vice President of the investment house of W. A. Harriman & Co., Inc., and a director of Music Master, will become a member of the Ware board and Chairman of its Finance Committee to represent the interest that Music Master has acquired in that company.

Papers in two actions for \$50,000 each against Shelp & Vandergrift, the Music Master Corporation and William Eckhardt, President of the last named concern, which has offices in the Gotham Bank Building, at Broadway and Fifty-ninth Street, New York City, were filed with the Queens County Clerk by Adelbert T. Emerson of Jamaica, Queens, who charges breach of contract. He alleges that the defendant concern violated exclusive sales rights which he says he held on the "Music Master" type of radio amplifying horn.

BATTERY MARKERS INSURE SAFETY

PAUL GLAMZO, 203 Lafayette Street, New York City, manufacturers of the handy solderless lug and the Glamzo Angle Irons, has brought out a set of battery markers that should find favor with every radio fan in the country. The Glamzo Battery Lead Tags are stamped out of durable metal, nickle-plated, plainly marked "B—" "A—" etc., a complete set serving for top and bottom of each A and B battery lead. The use of these enables the fan to hook up or disconnect and to change sets with assurance of safety against blow-out. Sets equipped with them will be easy for the layman to hook up. Some persons find it hard to understand the simple directions enclosed with the factory-made set, but the markers would make the situation plain.

(Tested and Approved by RADIO WORLD Laboratories).

equipment, and lines representing over 135 manufacturers.

The great event of the show was the amateur set building contest, in which were entered over 280 sets, all built by non-professionals and ranging from crystal sets to the most modern Super-Heterodynes. Over \$1,200 in prizes was awarded, including \$425 in sweepstake prizes. The set judged the best from the standpoint of construction, stability, performance and distance getting powers was the Silver-Marshall Super-Heterodyne seven-tube set, built and entered by Robert Haig, of this city, who was awarded the sweepstake prizes. The second prize was awarded to D. Kean who had entered a Best 45,000 cycle Super-Heterodyne receiver.

An interesting feature of the show was wavelength transmission and reception given by the Amateurs' Radio Relay League, on wavelengths between 5 and 200 meters.

THE RADIO TRADE

DUNLAP'S RADIO CALL BOOK

FOR those who desire an up-to-date list of broadcasting stations of the country in book form "Dunlap's Radio Call Book and Monthly Service," fills the bill. This booklet is made up by Orrin E. Dunlap Jr., radio editor of the N. Y. "Times," and contains a full list of all the stations in the world. The stations are grouped and arranged alphabetically. There is sent to the owner of this booklet every few weeks, an extra page, which is pasted in the back of the booklet and which has a corrected or revised list of stations up to date. Mr. Dunlap's address is Box 88, Flushing, N. Y.

Coming Events

AUG. 22 to 28—3d Annual Pacific Radio Exposition, Civic Auditorium, San Francisco. Write P. R. E., 905 Mission St., San Francisco.

SEPT. 5 to 12—Third annual National Radio Exposition, Ambassador Auditorium, Los Angeles, Cal. Address Waldo K. Tupper.

SEPT. 6 to 12—National Radio Exposition, Grand Central Palace, N. Y. C. Write American Radio Exp. Co., 522 Fifth Ave., N. Y. C.

SEPT. 9 to 20—International Wireless Exposition, Geneva, Switzerland.

SEPT. 14 to 19—Second Radio World's Fair, 258th Field Artillery Armory, Kingsbridge Road and Jerome Ave., N. Y. C. Write Radio World's Fair, Times Bldg., N. Y. C.

SEPT. 14 to 19—Pittsburgh Radio Show, Motor Square Garden. Write J. A. Simpson, 420 Bessemer Bldg., Pittsburgh, Pa.

SEPT. 14 to 19—Radio Show, Winnipeg, Can., Canadian Expos. Co.

SEPT. 21 to 23—International Radio Exposition, Steel Pier, Atlantic City, N. J.

SEPT. 28 to OCT. 3—National Radio Exposition, American Exp. Palace, Chicago. Write N. R. E., 440 S. Dearborn St., Chicago, Ill.

OCT. 3 to 10—Radio Exposition, Arena, 46th and Market Streets, Philadelphia, Pa., G. B. Bodenhopf, manager, auspices Philadelphia Public Ledger.

OCT. 5 to 10—Second Annual Northwest Radio Exposition, Auditorium, St. Paul, Minn.

OCT. 5 to 11—Second Annual Radio Show, Convention Hall, Washington, D. C. Write Radio Merchants' Association, 233 Woodward Bldg.

OCT. 12 to 17—Boston Radio Show, Mechanics' Hall. Write to B. R. S., 209 Massachusetts Ave., Boston, Mass.

OCT. 12 to 17—St. Louis Radio Show, Coliseum. Write Thos. P. Convey, manager, 737 Frisco Bldg., St. Louis, Mo.

OCT. 12 to 17—Radio Show, Montreal, Can., Canadian Expos. Co.

OCT. 17 to 24—Brooklyn Radio Show, 23d Regt. Armory. Write Jos. O'Malley, 1157 Atlantic Ave., Brooklyn, N. Y.

OCT. 19 to 25—Second Annual Cincinnati Radio Exposition, Music Hall. Write to G. B. Bodenhopf, care Cincinnati Enquirer.

NOV. 2 to 7—Radio Show, Toronto, Can., Canadian Expos. Co.

NOV. 3 to 8—Radio Trade Association Exposition, Arena Gardens, Detroit. Write Robt. J. Kirschner, chairman.

NOV. 19 to 25—Milwaukee Radio Exp., Civic Auditorium. Write Sidney Neu, of J. Andrae & Sons, Milwaukee, Wis.

NOV. 17 to 22—4th Annual Chicago Radio Exp., Coliseum. Write Herrmann & Kerr, Cort Theatre Bldg., Chicago, Ill.

Business Opportunities Radio and Electrical

Rates: 50c a line; Minimum, \$1.00

CONSULTING RADIO ENGINEER WISHES contact with individual having radio sales experience and capital to organize small radio manufacturing and sales company. Box AA, RADIO WORLD.

LARGEST DEPARTMENT STORE IN BATTLE Creek Mich., willing to go into partnership with some one who understands radio business, or will rent department to them on percentage basis. Box 63, 238 West 42d St., New York City.

LET US BE YOUR FACTORY AND PUT up your article, relieving you of all detail; we are specialists in assembling, cartonizing and shipping products for the cosmetic and drug trade. B. H. & Co., 444 West 26th St., New York City. Chickering 1164.

MR. DX HOUND

A Character Created
by RADIO WORLD Artist

By **HAL SINCLAIR**



"GOLDEN AGE" OF INDUSTRY AT HAND, SAYS SCHWAB

INDUSTRY is entering upon the "golden age," in the opinion of Charles M. Schwab, who said:

"Great industrial success has been built and will be built in cooperation, frank comparison of results and honest competition in effecting economies, not only among the units of our great industries, but among workmen, investors and managers. That spirit will make the United States impregnable in the industry of the world."

KIRCHNER HEADS SHOW EXECUTIVES IN DETROIT

THE Radio Trade Association of Michigan announces the appointment of the following show and advertising committees for the exposition which will be held Nov. 3 to 8 at the Arena Gardens: Robert J. Kirchner, chairman; G. W. Russell, manager; A. M. Edwards, executive secretary; H. J. Van Baalen, treasurer; G. Seely, construction; C. W. Kirby, advisory.

PHILADELPHIA SHOW OCT. 3 PHILADELPHIA.

A RADIO exposition of national scope which will present the latest in radio equipment will be held here at the Arena, at 46th and Market Streets, here October 3 to 10, inclusive. It is being sponsored by the Philadelphia Public Ledger and will be managed by G. B. Bodenhof of Cleveland who successfully conducted similar expositions in Buffalo and Cincinnati last season. This exposition probably will be widely advertised.

Move Begun to Limit Frequency of Broadcasting Popular Songs

Nothing to Do With Kilocycles; Just Song Publisher's Life Extension Institute for Fast-Perishing Masterpieces of Jazz.

BROADCASTING may stimulate for a time the sale of sheet music, but in the long run it hurt the retail music trade. This was the consensus at the concluding session of the annual convention of the National Association of Sheet Music Dealers, at the Hotel McAlpin, New York City. A resolution was adopted pledging the cooperation of the association with the music publishers in their efforts to have broadcasting subject to the same copyright and royalty regulations as are other forms of public performance.

Some dealers said that the sale of certain kinds of sheet music was unquestionably increased through the advertising they received by the radio: The latest jazz hit, it was pointed out, would have a marked success with radio fans, but for only a very few weeks. The reason, it was said, was that radio audiences hear the tune from every station, many times each day, and are soon so tired of it that there is no possi-

The Retort Courteous

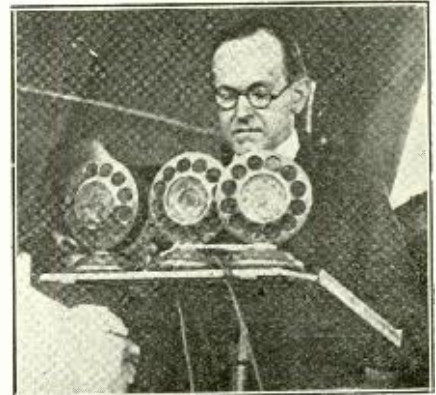

PRESIDENT COOLIDGE at the microphone of the WCCO, Minneapolis-St. Paul, Minn. The event was the celebration of the Norse Centennial. "Let those who are dissatisfied with this country leave it," President Coolidge said. We're staying. (Fotograms.)

bility of a continued sale of the music for several months, as was usual in former years.

It was admitted that the demand for music of a semi-classical nature, as well as for standard songs, is increased by broadcasting, especially if they happen to be interpreted by good artists. Many songs of a generation ago, it was pointed out, which had been forgotten, have recently been revived through the radio.

Samuel Fox, music publisher, declared that the real solution of the copyright problem will be the regulation of broadcasting stations by the publishers as regards the frequency and manner of broadcasting popular hits. In this way, he said, publishers could prevent compositions from losing their popularity in a few weeks through being played too often.

Mr. Fox asked that the conference strike out those portions of the record containing statements of dealers that broadcasting helped sales. He contended that if such statements of a minority were included in the official report they might have an adverse effect on the publishers' campaign to uphold the copyright law.

THE BABY PORTABLE, by Herbert E. Hayden. A 1-tube DX set on a 7 1/4 x 5 1/2" panel. Send 30c for May 16 and 23 issues to RADIO WORLD, 1493 Broadway, New York City.

A DX TRANSMITTER, by C. H. West, May 23 issue, RADIO WORLD, 15c.

Beam Radio Under Inquiry for British Empire Linkup

ENGLAND'S dream of an eternal empire bound together by common ties is now taking shape as an empire at least partially united by wireless. Radio in England is under the control of the Postmaster-General, and that official in a recent report summarized all of Britain's plans for an imperial radio system.

Until the Marconi company produced the beam system, which they claimed would provide adequate service at a much lower cost, the policy has been to provide imperial wireless communication by a chain of high power stations. Under this policy the high power station at Rugby was authorized and is now being constructed. But later the Government decided to give the beam system a thorough trial, and the governments

of the various colonies concurred in this decision.

An agreement was therefore made with the Marconi company to provide beam stations for the whole empire. Sites have been selected in Canada, South Africa, India and Australia, and have been purchased in the former two cases. Under the agreement the company has contracted to complete stations within nine months after the sites have been handed over to them. The Canadian and South African stations must therefore be completed by next October.

To work out the details of the system invitations have been issued to the colonies and India to nominate representatives to serve on a permanent committee to decide the questions at issue.

Munson's Powerful Circuit

(Concluded from page 6)

and squealed and squawked more than a regenerative receiver.

2. There were too many control knobs fictitiously labelled "volume" "quality" etc., and it was observed that many persons knew nothing of the principles of these controls and used them indiscrimin-

SOLVED!

—THE "B" BATTERY PROBLEM

Throw away your "B" Batteries and install a Kellogg Trans-B-Former. It gives you "B" Battery current direct from your electric light socket at the trifling cost of one-fifth of a cent per hour. Gives better reception—no interferences. Write for details.

Kellogg Switchboard & Supply Co.
Trans-B-Former
1066 West Adams Street Chicago, Ill.

The Same Parts Used in My

Pocket Book Portable

Complete Kit \$9.37

Send Money Order Now to

Burton Lindheim

331 WEST 101ST STREET
NEW YORK CITY

THE RAMBLER SIX A REAL PORTABLE

Volume, Clarity, Portability, Durability and Beauty Unequaled

Lightest in weight. 21 pounds.
Smallest in size. 14x9½x9¾ inches.

LIST PRICE **\$80.00**

If your dealer cannot make immediate delivery we will ship direct from factory same day your money order or check is received.

American Interstate Radio Service

183 Greenwich Street, New York City
Distributors, Jobbers, Dealers, write for special trade terms.

RADIO MAILING LISTS

17017 Radio Dealers, U. S., by States	per M	\$7.50
5000 Radio Dealers, Foreign Countries	per M	7.50
1879 Radio Mfrs.	per List	20.00
2470 Radio Supply Jobbers	per List	20.00
1125 Radio Supply Jobbers, rated \$5000 up	per List	18.00
714 Radio Supply Jobbers, rated \$50,000 up	per List	10.00
802 Radio Mfrs. making complete sets	per List	10.00
163 Radio Battery Mfrs.	per List	3.00
200 Radio Cabinet Mfrs.	per List	4.00
852 Phonograph and Music Radio Dealers	per List	10.00
82 Phonograph and Music Radio Jobbers	per List	3.00

All guaranteed 98% correct. Ask for General Price List all other Radio Lists.

A. F. WILLIAMS, Mgr.
166 W. Adams Street Chicago

LIST OF PARTS

- Three .0005 mfd. Heath Radiant Variable Condensers (No. 23A).
- Three stage Heath Radiant Resisto Former.
- Three Hi-Constron tubes for resistance AF.
- Two Heath sockets (No. 206) for RF and detector.
- One A battery switch S1.
- Three Summit RF transformers.
- Three rheostats.
- One grid condenser .00025 mfd. (C4).
- One grid leak, 2 meg. (R3).
- One SC jack (J2).
- One fixed condenser, .002 (C5).
- Batteries, aerial wire, two 201A tubes, speaker, ground clamp, lead-in wire.

ately, hoping by some odd chance to strike a good combination.

3. It was learned that many a set operated very poorly or was even entirely inoperative due to battery trouble. In investigating many such cases of inoperative receivers it actually became monotonous to hear the owners assure you that it couldn't be worn-out batteries, because they just bought new ones recently; but it often developed that perhaps the children turned the bulbs on and they burned several days or perhaps an "expert" friend tested the B batteries with an ammeter and pronounced them O. K. In any event battery trouble was the greatest cause of inoperative receivers.

4. Many a fan had constructed his own 5-tube receiver and it never did work properly in spite of his elaborate workmanship and the helpful directions which accompanied his kit. In fact many of the present home-made 5-tube sets would give better results if the first two tubes were cut out entirely and only the detector and audio-amplifiers employed.

For these reasons the following points were decided upon and form the essential features of the set about to be described:

1. It should have a minimum of controls, consistent with efficiency.
2. It must omit all unnecessary apparatus.

3. It should be so simply that the average layman could construct it without trouble and have it equal the 4-tube sets.

Many schemes were tried. We used spider-web coils, basketweave coils, tube wound, D coils and others, but finally picked the toroidal coil. These should be of the proper inductance for the condensers used. The photographs show .0005 mfd. Heath Radiant condensers, the coils being in round housings to the rear of each condenser.

Resistance-coupled AF was used, because of the quality it produces. The set is wired left to right (Fig. 2) for the RF and detector, right to left on the audio. This brings the sole jack at left (Fig. 3).

Heath's Radiant Resisto Former was used for the three AF stages. It is a complete unit, the wiring shown in Fig. 5 for the AF being unnecessary to follow, since the posts on the unit are marked.

The tubes used were Hi-Constron, a Clearstone product, especially adapted for resistance AF. The tube works as detector and RF amplifier, but is not recommended for such. It stands a very high plate voltage and is especially a resistance AF tube.

Those who decide to build the set, without using toroidal coils, may wind 10-turn primaries, 45-turn secondaries, on 3½" diameter tubings, for L1, L2, L3, L4, L5, L6, although L6 may require less than 45 and nearer 35. Spiderweb coils could be 15-turn primaries at hub, 50-turn secondaries, total diameter 5½". The wire is No. 22 SCC, but the toroids are better here.

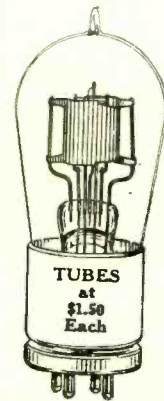

SAVE \$1.50
ON COST OF NEW TUBES BY HAVING YOUR OLD TUBES REBUILT
AT \$1.50 EACH

Guaranteed equal to new. Send us your tubes by parcel post. We return them parcel post, C.O.D., and try to maintain 24-hour service.

400 Old Colony Ave.
Boston, Mass.
HARVARD RADIO LABORATORIES

DX, VOLUME, SELECTIVITY

All Three Marvelously Combined in



"A Gem, a Jewel and a Joy"

Described by Herman Bernard in the April 4, 11 and 18 issues, with trouble-shooting in the April 25 issue. That is the 3-control set.

The Diamond as a 2-control set, using a double-condenser, was described in the May 23 and 30 issues. If you are going to build the 2-control set, be sure to get the four other numbers also, for full information.

Either set works fine on loop or outdoor aerial.

Get your full measure of enjoyment from radio reception by building this set. Just the thing for fine summer reception.

Send 60c for the April 4, 11, 18 and 25 issues, or 90c for those and the May 23 and 30 issues, or start your subscription with the earliest dated number. Send \$4.00 for yearly subscription and these six numbers will be sent free. Address Circulation Manager, RADIO WORLD, 1493 Broadway, New York City.

FILL OUT AND MAIL NOW

SUBSCRIPTION BLANK

RADIO WORLD

RADIO WORLD

Please send me RADIO WORLD for months, for which please find enclosed \$.....

SUBSCRIPTION RATES:

Single Copy	\$.15
Three Months	1.50
Six Months	3.00
One Year, 32 Issues	6.00
Add \$1.00 a Year for Foreign Postage; 50c for Canadian Postage.	

1493 Broadway, New York City

The Weekly Rebus

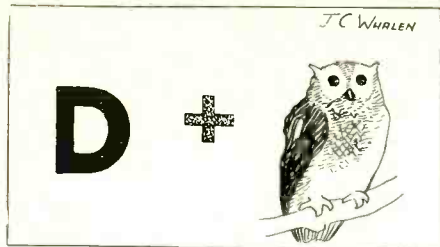

For Battery, Antenna and Ground Leads—

Jones MULTI-PLUG

THE STANDARD SET CONNECTOR

HOWARD B. JONES
618 S. CANAL STREET CHICAGO

NOW \$3.50 C.O.D.

Direct from factory to you

THE RABAT SENIOR

4200 MIL. AMPS CAPACITY

For a Limited Time Only

You can purchase for \$3.50 a 12 cell 24 volt RABAT SENIOR battery. Saving \$6.10 thru direct buying. 24 cell 48 volt size \$7.00

Rabat Senior batteries are neat, powerful, noiseless. Separate clear glass cells and patented rubber cork with heavy duty plates 3/16" x 1" x 2 1/2" with singed ribbed grid form the backbone of this sturdy battery. Shipped completely charged ready to use. Order now, save \$6.10

Rabat Super Charger \$3.00 c. o. d.

Specially designed to satisfactorily recharge any storage "B" battery. Shipped complete ready to use, including lamp socket, attachment plug and cord. You save \$1.30 by ordering direct.

Send No Money but order today. After examining and approving these batteries pay Expressman the small c. o. d. charges. RABATS are guaranteed two years.

THE RADIO RABAT COMPANY
1766 ST. CLAIR AVE. CLEVELAND, OHIO

RADIO WORLD

FROM NOW UNTIL

September 26

For \$1.50

Don't fail to read RADIO WORLD right straight through the Summer and thus be sure of getting the finest service possible out of your set.

RADIO WORLD

1493 Broadway New York City

Another City Runs Station

Brownsville, Texas, is Licensed, As Is "Radio News," New York.

WASHINGTON. THREE new class A broadcasting stations were licensed by the Department of Commerce. They follow:

Station	Location	Meters	Watts
KWWG	City of Brownsville, Brownsville, Texas.	278	500
WRNY	Experimenter Pub. Co., (Radio News) New York, N. Y.	258	500
KFVY	Radio Supply Co., Albuquerque, N. M.	250	10

MAKING AC POWER UNIT

(See June 20 issue.)

In order to have the dimensions of the filter choke coils small, fine size wire must be used. This is permissible on small plate current, and even number 40 wire can be used up to ten or possibly to twenty milliamperes load. This, however, introduces considerable resistance which will make an IR drop. So the arrangement using such small coils will need to employ a step-up transformer ahead of rectification. For example, the 110 volts AC can be stepped up to 250 volts, rectified, then passed through the small coils of high impedance. Then the shunt filter condensers can be of small size, usually 1 to 2 MF. total.

If the coils for this are not available, the secondary coils of ordinary cheap type audio transformers can be impressed into service, both in making up the step-up transformer and in service as choke coils of filter. The iron cores will be used as usual. As choke coils, the primary windings will not need to be used, as the secondary windings are better and can pass sufficient plate current when the step-up transformer arrangement is used. 1 to 4 ratio coils can be conveniently used, though others may be made to do. Then the DC output can be had substantially inaudible on loud speaker. A voltmeter of high resistance type is useful in making

adjustments for voltage of output side of power unit.

The cost of a complete B battery substitute unit using four electrolytic cells, a step-up transformer, two high impedance chokes, and two telephone condensers, giving sufficient plate current for average five-tube set, need not exceed \$5. As an improvement the next step would be the use of a full wave electron tube rectifier, which with bulbs would probably cost \$20 complete. Using make-shift 1158 tube rectifiers this can be put together for \$10.

Twenty-five cycle sources of alternating current will be difficult to filter and require large sizes of coils and condensers.

Solid Rubber Case

You Save 50%

World 6-Volt Storage Batteries are famous for their guaranteed quality and service. Backed by years of Successful Manufacture and Thousands of Satisfied Users. You save 50% and get a

2-Year Guarantee Bond In Writing

World Battery owners "tell their friends." That's our best proof of performance. Send your order in today.

RADIO BATTERIES		
6-Volt, 100-Amperes	\$12.25
6-Volt, 120-Amperes	14.25
6-Volt, 140-Amperes	16.00

AUTO BATTERIES		
6-Volt, 11-Plate	\$12.25
6-Volt, 13-Plate	14.25
12-Volt, 7-Plate	17.00

SEND NO MONEY

Just state battery wanted and we will ship day order is received, by Express C. O. D., subject to your examination on arrival.

Extra Offer: 5% discount for cash in full with order. Buy now and get a guaranteed battery at 50% saving to you.

WORLD BATTERY COMPANY
1219 S. Wabash Ave., Dept. 17 Chicago, Ill.

World

Approved and Listed as Standard by Leading Authorities including Radio News Laboratories, Popular Science Institute of Standards, Popular Radio Laboratories, Radio Broadcast Laboratories and Lefax, Inc.

Solid Rubber Container

Now Standard equipment on all World Storage Batteries. No more leakage or breakage of jars or rotting of box.

THE NEW RADIO TUBE

Designed especially for resistance

COUPLED AMPLIFIERS

Tested and approved and used By Radio World

HI-CONSTRON

Type C. T. 101A

Another Cleartron product—the tube that gives greater volume, better quality at one-third the plate voltage. Designed for Resistance, also Intermediate steps of Superhetrodyne and in Radio frequency receivers.

AMPLIFICATION CONSTANT 20
(Almost 3 times that of 201A)

5 VOLTS 3/4 AMP.

Price \$3.00

Manufactured by

CLEARTRON

28 WEST 44th ST. NEW YORK

You can't lose, for Cleartron is backed with ironclad guarantee to make good.

The Pocketbook Portable; A Home-Made 4-Tuber

(Concluded from page 4)

to bottom R5 to bottom of J. Be sure to verify connections before attaching batteries.

A Loop

Around the four small brass brackets on which the set stands may be wound a loop, which consists of 25 turns of bell wire (No. 18).

Tuning

The set is tuned as follows: Point the set so that the horizontal strands of the

loop point in the direction of the station to be received. Adjust the right-hand dial, which controls wavelengths. Adjust the left-hand dial, which controls volume. Retune, if necessary.

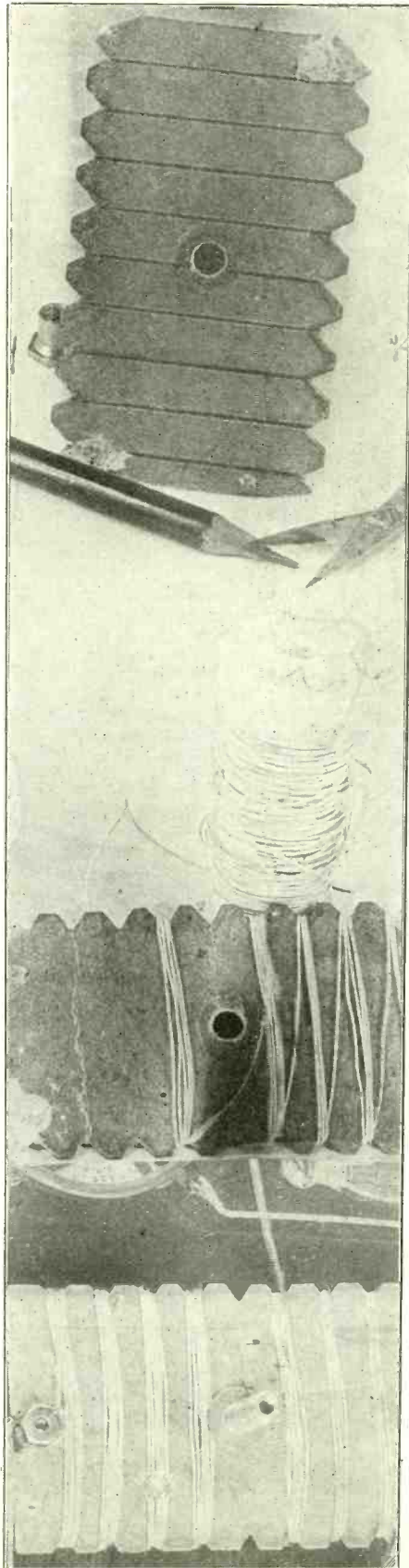

THE FORM for making the variometer is shown at top, properly notched. The winding is begun (middle photo). How the coil looks when completed is revealed in the bottom view. The shaft is shown inserted.

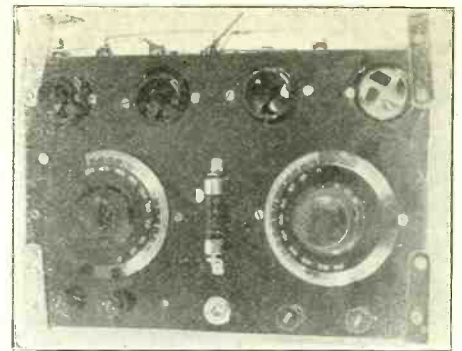

THE panel view, with amperite on front. For 4 tubes on 6 volts use regular 201A amperite (No. 1A).

S-U-P-E-R-D-Y-N-E

SPECIALISTS

The Famous Wallace Low-Loss Coil for Superdyne...\$7.50
The Flewelling Condenser for Superdyne...\$9.00
Superdyne Advice Free. Mail Orders Solicited.

WALLACE RADIO COMPANY, Inc.
135 LIBERTY STREET NEW YORK CITY

LOUD SPEAKER RECEPTION

from either coast on three tubes.

Blueprint and instructions.....\$1.00
Necessary low loss coil.....\$2.50
Beautiful finished instrument.....\$35.00

S. A. TWITCHELL CO.

1930 Western Avenue Minneapolis, Minn.



Sterling Five

Highest quality five tube tuned radio frequency set in solid mahogany cabinet. List Price,

\$60.00

Write for free Log Book. Gibson-Sears Radio Corp. 48 W. Broadway, New York

Reg. Trade Mark.

RADIO CATALOG

AND HOOK-UPS FREE

Our great new catalog, fresh from the press, contains the very newest in complete sets, parts and accessories—hundreds of amazing bargains. 250,000 customers testify to our wonderful values and reliability. Complete instructions with diagrams for making most practical popular sets FREE. SEND QUICK for your copy. (Please include name of friend who is interested in Radio.)

THE BARAWIK CO. 102-104 So. Clinton St. Dept. 121 Chicago

BATTERY LEAD TAGS



SET OF TEN TWO OF EACH SAFE & QUICK 15 PRICE CENTS

MFD. BY PAUL CLAMZO 203 LAFAYETTE ST. NEW YORK

ACME

for amplification

ULTRA-VERNIER TUNING CONTROL

A VERNIER DIAL ON WHICH YOU CAN PENCIL RECORD THE STATIONS. GEARED 20 TO 1. SILVER FINISH \$2.50 GOLD FINISH \$3.50

PHENIX RADIO CORP., 118-F East 25 St., N.Y.C.



Famous for Quality and Service

Amplitron Tubes

Bonded to Give Service \$3

List Price.....\$2.50

Send in your old and burnt out Tubes—We will send you new AMPLITRON—any model—at.....\$2.50

Dealers and Jobbers—Write for Discounts

Pennant Radio Laboratories

Dept. R.W., 28 Central Ave., Newark, N. J.

Now and Improved FRESHMAN MASTERPIECE

5-Tube Tuned Radio Frequency Receivers

Sold by Authorized Freshman Dealers Only

HERCULES AERIAL MAST



20 Ft. Mast \$10
40 Ft. Mast \$25
60 Ft. Mast \$45

All steel construction, complete with guy wires and masthead Bulley. We pay the freight. S. W. HULL & CO., Dept. E3 2048 E. 79th St., Cleveland, O.

FREE literature and Write for Blueprint

A RECHARGEABLE "B"

WITH A STRONG GUARANTEE

The SEE-JAY BATTERY has met all tests and is endorsed and recommended by the Washington Information Service Bureau and more than 20,000 satisfied users. Genuine Alkaline connected elements; strictest Government test passed and recommended. No drilling or wiring. Connectors crimped under 1,000-pound pressure. Save time, temper and money. 100-volt unit, \$7; 140-volt, \$10. Why pay more? Complete assembled batteries, solution separate, shipped dry, 100-volt, \$12.00; 140, \$16.00. See-Jay unit sold on money-back guarantee. Write for literature and send 20c for improved sample cell. SEE-JAY Battery Co., Dept. W, 915 Brook Ave., New York. Mail order service.

WHOLESALE AND RETAIL

A \$5 HOME-MADE LOUDSPEAKER, by Herbert E. Hayden, in Feb. 7 issue. Send 15c for copy, RADIO WORLD, 1493 Broadway.

BABY PORTABLE SET

How to make it. See RADIO WORLD, dated May 16, 15c. per copy, or start your subscription with that number. RADIO WORLD, 1493 Broadway, New York City.

A SIMPLE 1-TUBE DX SET FOR THE NOVICE, by Percy Warren. Send 15c for May 23 issue, RADIO WORLD.

A 3-TUBE REFLEX FOR THE NOVICE, by Feodor Roipatkin. Schematic and pictary diagrams, panel and assembly. Send 15c for March 28 issue of RADIO WORLD.

HOW TO BUILD A NEUTRALIZED LOOP, by Frank Freer. Send 15c for May 2 issue, RADIO WORLD.

THE 1-A PORTABLE, 1925 Spring Model, a 2-Tube Set of Great DX Powers. Two controls. Described by Herbert E. Hayden in RADIO WORLD, issues of March 28, April 4 and April 11, with trouble-shooting article in April 18 issue. Profusely illustrated, including templates. Send 60c, get all four copies. Address Circulation Manager, RADIO WORLD, 1493 Broadway, New York City.

HAVE YOU ANYTHING TO SELL OR EXCHANGE? Use RADIO WORLD'S Classified Department and get great results. RADIO WORLD, 1493 Broadway, N. Y.

Portable Super-Heterodyne Uses 6 Tubes, one AF and one IRF Being Omitted

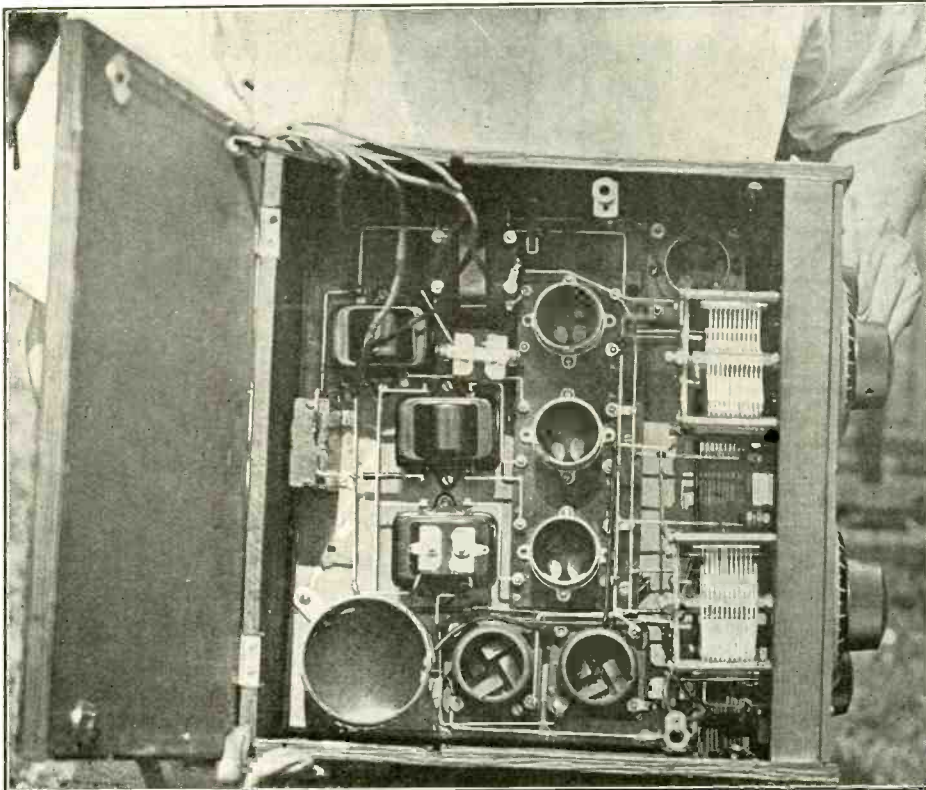

LAYOUT of a 6-tube Super-Heterodyne receiver. By eliminating one stage of intermediate and one stage of audio amplification, the six tubes were accomplished. (Kadel & Herbert.)



AL ODORF, operating the 6-tube Super-heterodyne he built, pictured also above. (Kadel & Herbert.)

**WRITE FOR
NEW CATALOGUE**
Home of Semi-Assembled Kits
THE RADIO SHACK
55 Vesey Street Dept. E-157 New York

KESTER Radio SOLDER
(Ros-a-Core)
If your dealer cannot supply you
send us 25c in postage
CHICAGO SOLDER COMPANY
CHICAGO, U. S. A.

**RESISTANCE COUPLED
AMPLIFIERS**
A new booklet that tells how
to obtain wonderful tone
with your present set at
very low cost.
Only 10 Cents Postpaid
COLE RADIO MFG. CORP. BLOOMFIELD, N. J.

FAVORITES AT KODEL STATION



NORNNE GIBBONS, whose contralto voice puts all the necessary "blue" into the popular melodies that she sings, and Lelia Le Marr, musical director of WKRC, the Kodel Radio Corporation's Station, Cincinnati, O. This peppy pair will be on the air at this station every Monday night after midnight. (Kodel Studio.)

CROSLEY
RADIO CATALOG FREE
Describes fully the complete line of radio frequency sets, regenerative sets (licensed under Armstrong U. S. Patent No. 1,113,149) and parts.
Write for Catalog Today
THE CROSLEY RADIO CORPORATION
POWEL CROSLEY, Jr., President
6404 Sasfras Street Cincinnati, Ohio

Vacation Specials

- Federal 65 and 65A Transformers.....\$4.55
- Daven Resistances 25% off list price.
- General Instrument .0005 Low Loss Cond.\$2.95
- Timmons A.C. B-liminator Kits.....\$16.00
- Accuratune 4" Vernier Dials.....\$2.65
- Eastern Superdyne Low Loss Coils.....\$5.95
- Bruno Condenser for 1 Dial Neurodyne.....\$4.75
- Brownlie Vernier Detectors.....\$1.50
- McCullough A.C. Tubes.....\$5.75

Bruno Parts in Stock. Lowest Prices on All Standard Parts.

George's Radio Shop

214 St. Nicholas Ave. New York City

THE Summit TOROIDAL

RADIO FREQUENCY TRANSFORMER

HERE IS THE POWER HOUSE
of the Radio World Power House Set

Two of these transformers pick up and amplify the very weak signal of the distant station and the third is the "POWER HOUSE,"—an immense reservoir of energy which may be used at will to give any desired volume.
Read Radio World article on the "Power House Set."

List \$10.00
(Set of 3 mated units)
Distributors and Jobbers
Wanted
**Summit Radio Mfg.
Co., Inc.**
Dept. 50
485 Broad Street
Newark, N. J.

EVEREADY Radio Batteries

-they last longer

EVERY SET BUILDER
NEEDS
THIS

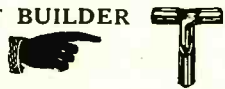

"Morsing Bus-Bar Union"

Makes for quick assembling. Repairs can be made by using Morsing Bus-Bar Union without taking set apart.

Assemble round or square Bus-Bar and solder three wires at a time. Order No. 1 for No. 14, No. 2 for 12 wire. Send 25 cents for enough for building one set, or ten dozen for \$1.00.

Newark Watch Case Material Co.
15 Ward Street Newark, N. J.
DISTRIBUTORS WANTED

Tested and approved by Radio World

"TRI-TUNER"



Build Your Own Set!
Use Arc Rad Products.
A Three-Circuit Coil, all
Litz wound on natural
bakelite.

SENT POSTPAID **\$3.00**

Panel shield and hook-
ups included. Fahne-
stock clips used.

Eliminate Soldering

ARC RAD PRODUCTS

48 South 7th Street Newark, N. J.
EVERY PRODUCT GUARANTEED



BUY THE
FILKO LIGHTNING
ARRESTER
SCIENTIFICALLY CORRECT
with the "100% Guarantee"

Warranted to protect your radio
from lightning, with a guarantee
to pay you \$100 or to repair
your set, should it be damaged
by lightning through any fault
of the arrester.

Listed as STANDARD
under the re-examination ser-
vice of the National Board
of Fire Underwriters.

If your dealer has none, send his
name with remittance direct to
Dept. RW-627.

DX INSTRUMENT CO.
Harrisburg, Pa.

GEM TUBE

A Guaranteed Radio Tube
Within Reach of All

Every tube guaranteed. A tube
for a dollar of \$2 value. A
trial order will convince you as
it has thousands of others.
Send your orders at once.

Orders sent C.O.D. parcel post.
Type .201A
Type .200
Type .199
Type .198A

(with standard base) EACH
Dealers. Write for Discounts
GEM TUBE CO.

Dept. W, 200 Broadway, N. Y. C.
220 So. State St., Chicago, Ill.
Lafayette Bldg., Detroit, Mich.



RECENT BACK NUMBERS

of RADIO WORLD, 15 cent each, or any seven
for \$1. Address Circulation Manager, RADIO
WORLD, 1493 Broadway, New York City.

GETTING BETTER QUALITY FROM AUDIO,
by Brewster Lee. Last AF stage connected to
two tubes in parallel. Send 15c for May 16 issue
to RADIO WORLD, 1493 Broadway, New York
City.

NOTHING SHOCKING ABOUT THIS MOUNT FOR YOUR CRYSTAL

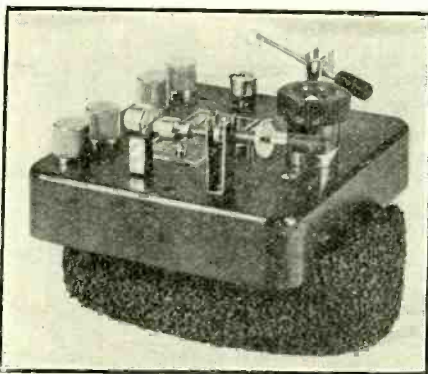

AN adjustable crystal detector, on sponge rubber,
with flexible leads, prevents jars. Glue the crystal
rubber to the baseboard and fasten the crystal base
to the rubber alone. (Hayden.)

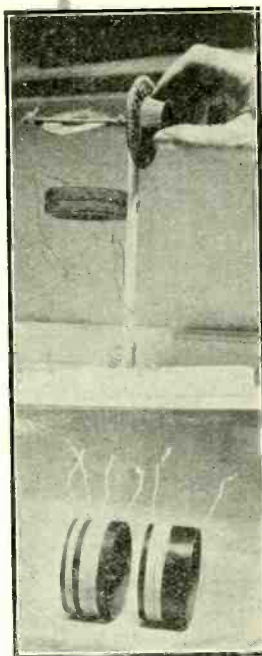

FOR short-wave reception
with the variable condensers
used in broadcast band re-
ception, the above coils will
do nicely. Top shows 20-
turn pancake, tickler 12-
turn primary, 16-turn sec-
ondary, using No. 24 silk
over cotton. Below, for tuned
plate, 8-turn primary, 16-turn
secondary and 12 turn plate
coil, with 22 SCC wire.
Diameters of all tubings are
3". (RADIO WORLD Staff
Photo.)

The Variometer Wavemeter

Take an ordinary variometer, and put it
in inductive relation to the antenna coil.
Tune the receiver until you hear a signal.
Now turn the variometer until the signal is
tuned out. Mark down the dial settings.
Calibrate all other receivers in the same
manner. When this is calibrated and you
wish to calibrate a receiver from the meter,
tune a signal in, turn the variometer until

ACME POWR-BEE

Better Than "B" Battery

NO HUM NO NOISE
Reduces the cost of radio. At your dealer's or write.

THE ACME ENGINEERING CO.
Dept. 3 LOUISVILLE, KY.

Dealers write for big sales proposition.

the signal is out and whatever the dial
reading of the variometer is represents the
wavelength of the station tuned out.

All the tables are variable, due to the
different types of receivers, including ma-
terial inside and therefore should not be
regarded as adamant. If you do not get
the exact numbers on dials for different
wavelengths that others got, your meter is
good, nevertheless.

FREE BOOKLET FOR INVENTORS

IF YOUR INVENTION is new and useful it is
patentable. Send me your sketch. Z. H.
POLACHEK, 70 Wall St., New York.
Reg. Patent Attorney-Engineer

"HOW TO MAKE—"

The following illustrated constructional
articles have appeared in recent issues of
RADIO WORLD:

- Sept. 6, 1924—A simplified Neutrodyne with
Grid-Biased Detector, by J. E. Anderson.
- Nov. 15—A Sturdy Low-Loss Coil, by Lieut. P. V.
O'Rourke. An Ultra 2-Tube Receiver, by
Byrt C. Caldwell.
- Dec. 6—A 6-Tube Super-Heterodyne Using a
Variometer, by J. E. Anderson. A \$1 Coil
Winder, by Herbert E. Hayden.
- Dec. 13—The World's Simplest Tube Set, by
Lieut. P. V. O'Rourke.
- Dec. 20—A 1-Tube DX Wonder, Rich in Tone,
by Herman Bernard. An Interchangeable De-
tector, by Chas. M. White.
- Dec. 27—A 2-Tube Variometer Set, by Lieut.
P. V. O'Rourke.
- Jan. 3, 1925—A 3-Tube Portable That Needs No
Outdoor Aerial, by Abner J. Gelula.
- Jan. 10—A Low-Loss DX Inductance, by Herbert
E. Hayden.
- Jan. 17—A \$25 1-Tube DX Wonder, by Abner J.
Gelula.
- Jan. 24—A Selective \$15 Crystal Set, by Brewster
Lee. A Variometer-Tuned Reflex, by Abner
J. Gelula. An \$18 1-Tube DX Circuit for
the Beginner, by Feodor Rofpatkin.
- Jan. 31—A Transcontinental 2-Tube Set, by H. E.
Wright. An Experimental Reflex, by Lieut.
P. V. O'Rourke.
- Feb. 7—The Bluebird Reflex, by Lieut. P. V.
O'Rourke. A \$5 Home-Made Loudspeaker, by
Herbert E. Hayden.
- Feb. 14—A Super-Sensitive Receiver, by Chas.
H. M. White. A Honeycomb RFT for DX,
by Herbert E. Hayden.
- Feb. 21—A 1-Tube Reflex for the Novice, by
Feodor Rofpatkin. A Set for Professional
Folk, by Lieut. P. V. O'Rourke. A Honey-
comb Crystal Receiver, by Raymond B. Wailes.
- Feb. 28—A Set That Does the Most Possible, With
6 Tubes, by Thomas W. Benson. Three
Resistance Stages of AF on the 3-Circuit
Tuner, by Albert Edwin Sonn.
- March 7—Storage B Battery, by Herbert E.
Hayden. Benson's Super-Heterodyne.
- March 14—The Reflexed 3-Circuit Tuner That You
Can Lose, by Herman Bernard.
- March 21—A Variable Leak, by Herbert E.
Hayden. A 4-Tube, 3-Control Set That Gets
the Most DX, by Lieut. P. V. O'Rourke.
- March 28—The Improved DX Dandy Set, by
Herbert E. Hayden. A 3-Tube Reflex for the
Novice, by Feodor Rofpatkin.
- April 4—The Diamond of the Air (Part 1), by
Herman Bernard. What the New 5000 Tube
Is, by Sidney E. Finkelstein. Sets for the
DX Devotee, by Lieut. P. V. O'Rourke.
- April 11—Audio Hookups for Fine Volume and
Quality as Well, by Brewster Lee. The Dia-
mond of the Air (Part 2), by Herman Bernard.
1-Tube Distance-Getting Sets, by Lieut. P. V.
O'Rourke.
- April 18—The Diamond of the Air (Part 3), by
Herman Bernard. The 7-Tube Pressley Super-
Heterodyne (Part 1), by Thomas W. Benson.
An Easy D Coil, by Jack Norwood.
- April 25—A 3-Tube, 2-Control DX Reflex, by
Brewster Lee. Trouble Shooting Article on
Diamond of the Air, by Herman Bernard.
Wiring the Pressley Set (Part 2), by Thomas
W. Benson.
- May 2—The Twinplex, by J. E. Anderson.
- May 9—A Set to Cut Static, by Feodor Rof-
patkin. Toroid Circuit with Resistance AF,
by E. I. Sidney. A Push-Pull AF Am-
plifier, by Lt. Peter V. O'Rourke.
- May 16—A 3-Tube Reflexed Neutrodyne, by
Percy Warren. The Baby Portable, by
Herbert E. Hayden. One Tube More for
Quality, by Brewster Lee.
- May 23—Powerful 3-Tube Reflex Receiver, by
H. E. Wright. The 2-Control Diamond (Part 1),
by Herman Bernard.
- May 30—Wiring the 2-Control Diamond (Part 2),
by Herman Bernard. 1-Control Neutrodyne,
by Sidney E. Finkelstein. Making Your Set
Tune the Entire Wavelength Band, by J. E.
Anderson.
- June 6—The Smokestack Portable, by Neal Fitz-
alan. A and B Battery Eliminators, Using
DC (Part 1), by P. E. Edelman. A Wav-
emeter, by Lewis Winner.
- June 13—Simple Short-Wave Circuits, by Herbert
E. Hayden. A Simple Push-Pull Rheostat, by
A. C. G. Force. A and B Battery Eliminators,
Using AC (Part 2), by P. E. Edelman. A
Portable Super-Heterodyne, by Wainwright
Astor.
- June 20—The Diamond as a Reflex, by Herman
Bernard. A 2-Tube Portable Reflex, by
Herbert E. Hayden. A Reflex for 99 Type
Tubes, by L. R. Barbley.

Any copy 15c. Any 7 copies, \$1.00. All these
31 copies for \$3.75, or start subscription with any
issue. Radio World, 1493 Broadway, N. Y. City.

Reinartz In Air Tests His Arctic Set

WASHINGTON.

THE short-wave radio equipment to be carried by the Naval planes with the MacMillan Arctic Expedition was tested in the air at the Naval Aircraft

Short-Wave Receiver Works Fine and Great Distance Feats Are Ex- pected on 38½ Meters.

Factory, Philadelphia. The set was taken aloft in one of the three Loening Amphibian planes to be used by Navy pilots with the expedition. The short-wave equipment is a tube set operating on 38½ meters. The power is supplied by batteries and the complete set weighs approximately 200 pounds.

In the Air 25 Minutes

The plane remained in flight for twenty-five minutes and operated within a radius of twenty miles from the Naval Aircraft factory. The plane was piloted by John A. Schur, one of the pilots of the expedition, and the radio set was operated by John L. Reinartz, radio engineer with the MacMillan party, designer of the set and also creator of the Reinartz Circuit. The radio set was heard at Hartford, Conn., a distance of 200 miles, and constant communication was maintained between the planes and a temporary station erected at the Naval Aircraft Factory.

Spark Set to be Used, Too

Standard Navy spark set equipment will also be carried by the Navy Detail with the expedition. This equipment was tested at the Naval Aircraft Factory several days ago and was found to work perfectly. Exhaustive tests have not been necessary, as equipment of this type has been delivering excellent service in Naval planes for several years. This equipment operates on a wavelength of 300 to 600 meters, the usual broadcast wavelengths, and the power for it is furnished by a wind driven generator on the plane. The

total weight of this equipment is just 58½ pounds. The Navy equipment has a reliable range up to 400 miles.

These two types of equipment will be carried by the Navy planes with the Arctic expedition, as the Navy set is necessary for use with radio compass direction finding equipment to be carried by the expedition and the short-wave set is expected to give communication over very great distances.

RADIO TUBES DIRECT

NO DEALER PROFIT

Postage Prepaid—Satisfaction Guaranteed
ONE—"Goode" Two-o-one A Tube \$1.89
THREE—"Goode" Two-o-one A Tubes 5.00
The above is a five volt, quarter-ampere tube for use on storage batteries and can be used either as a Detector or an Amplifier.

THE GOODE TUBE CORP., Inc.
OWENSBORO (Dept. B), KENTUCKY

PANELS

RADION and HARD RUBBER
RETAIL ANY SIZE WHOLESALE
PRICE LIST MAILED ON REQUEST

HARD RUBBER SHEETS—RODS—TUBING

Special Hard Rubber Parts Made to Order.
Send Sample or Sketch for Quotation.
NEW YORK HARD RUBBER TURNING CO.
212 CENTRE ST. NEW YORK

OPERATONE RADIO TUBES



Guaranteed
the Best

Type 201A
Type 200
Type 199
199 with Standard Base EACH \$1
Type WD12 \$1.25
Mail Orders Filled.
Dealers, Jobbers,
Write for Discounts

OPERATONE TUBE CO.

Room 411
324 West 42nd Street, New York City

SUMMER SPECIALS

Roberts 4-Tube Knockout Kit.....	\$42.50
Well-known 5-Tube T. R. F. Set.....	29.50
Hammerlund .0005 Condensers.....	4.00
Acme D. Coils.....	9.75
Ekko Stamp Albums.....	0.95
Brach Soldering Irons.....	1.65
Crosley Musicone Loud Speaker.....	13.95
Jewett Superspeaker.....	21.95
Little Gem Head Set.....	2.50

Send for our free summer special folder on sets and parts. Real bargains on standard parts and sets. You opportunity to save money.

LIBERTY MAIL ORDER HOUSE

Dept. S-100

106 LIBERTY STREET, NEW YORK, N. Y.

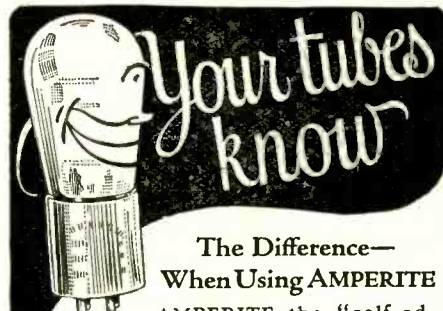

The Difference— When Using AMPERITE

AMPERITE the "self-adjusting rheostat", automatically controls the flow of current, and makes hand controlled rheostats obsolete.

Permits the use of any type of tubes or any combination of tubes. Specified in every popular construction set.

For perfect results you must use AMPERITE for filament control. Price \$1.10 everywhere.

RADIALL COMPANY

Dept. R. W. -9- 50 Franklin Street, New York City



Write for
FREE
Hook-ups

AMPERITE
REG. U.S. PAT. OFF.
"means right amperes"

Summer 2-For-Price-of-1 Subscription Offer

For NEW RADIO WORLD Subscribers Ordering NOW

Radio World has made arrangements

- To offer a year's subscription for any one of the following publications with one year's subscription for RADIO WORLD
- RADIO NEWS or -RADIO DEALER or
- POPULAR RADIO or -RADIO JOURNAL or
- RADIO BROADCAST or -RADIO (San Francisco) or
- WIRELESS AGE or -BOYS' LIFE

This is the way to get two publications

- for the price of one:
- Send \$6.00 today for RADIO WORLD
- for one year (regular price -for 52 numbers)
- and select any one of the other
- eight publications for twelve months.
- Add \$1.00 a year extra for
- Canadian or Foreign postage.
- Present RADIO WORLD subscribers
- can take advantage of this offer by
- extending subscriptions one year
- if they send renewals NOW.

RADIO WORLD'S SPECIAL TWO-FOR-PRICE-OF-ONE SUBSCRIPTION BLANK

RADIO WORLD, 1493 Broadway, New York City.
Enclosed find \$6.00, for which send me RADIO WORLD for twelve months (52 numbers), beginning..... and also without additional cost, Radio News, or Popular Radio, or Radio Broadcast, or Wireless Age, or Radio Dealer, or Radio Journal, or \$10.00 for two yearly subscriptions.

Indicate if renewal.
Offer Good Until
June 30, 1925.

Name
Street Address
City and State.....

Sets Tuning in Lower Waves Suggested As Alternative to Limitation of Stations

By Thomas Stevenson

WASHINGTON.

THE Fourth National Radio Conference, which will be called by Secretary Hoover to meet in Washington during

Officials Turn to Manufacturers for Aid and May Seek to Compel It—Programs on 150-to-200 Band Another Proposal.

ing September, will have before it a harder problem than any presented at the previous annual events. Because of the rapid increase in the number of class B broadcasting stations a definite policy will have to be formulated as to the disposition of new class B applications for wavelengths. The conference probably will be asked to go on record as favoring a limitation of stations or else to suggest some way to take care of new applicants.

That there will be a fight over the proposition no one doubts. Government officials at Washington are divided on the proposals.

The approval of the Fourth National Radio Conference would not make any plan a law. Before it could be enforced Congress must enact legislation giving the Government the power to limit the number of stations.

Since it has been impossible to date to pass through Congress radio legislation, even that against which there was practically no opposition, it may take some time to enact a bill for which there is considerable opposition.

While the total number of broadcasting stations has not materially increased, the number of class B stations has jumped from around 50 last year to 88 at present. As there are less than 47 class B wavelengths the reason for much of the interference experienced recently is obvious.

Bad as the situation is, it threatens to grow worse. There are around 20 individuals and concerns now clamoring for wavelengths for new class B stations, with around fifty more considering the erection of new stations. Officials of the Radio Bureau of the Department of Commerce have warned these applicants that at present there is not a single wavelength available and that if they construct a station it will be at the risk of not being able to get a wavelength.

The answer to this warning has been: "Well, those fellows (referring to other class B stations) have a wavelength and we are just as much entitled to one as they are."

Under the law the Secretary of Commerce has not the authority to refuse a wavelength to any station that complies with the very few requirements of the 1912 Act. However, the Department of

Commerce cannot give something it does not possess. It is believed that it is only a question of time before some disappointed applicant will take the case to the courts in an effort to get a wavelength, presumably in an attempt to compel other stations to divide time.

It is believed by officials who have made a careful study of the situation that eventually the number of stations will be limited to the needs of each community and that new stations will be permitted only when an old station drops out. Some officials are in favor of allowing an equal number of wavelengths to each State. Under such a plan the state legislatures would have the job of assigning the wavelengths to various stations.

Some measure of relief from the present situation would be afforder if manufacturers would produce sets which would tune as low as 200 meters.

At present there are few sets which will go below 225 meters. The broadcast band

NEUTRODYNE KIT \$19.75
Complete kit of licensed Neutrodyne parts, including panel, tube sockets, rheostats, jack, fixed condensers and grid leak. Neutroformers complete with variable condensers and neutrodons. Every part included even to screws and wire. Easy read plans.
Send No Money Order by Postcard
Pay the Postman
RADIO SURPLUS STORES
HELENA MONTANA

THE ASTON CARD INDEX
RECORD YOUR RADIO STATIONS
\$3.00
Complete Postpaid
Copyright 1924 by S. T. Aston & Son
Telephone Franklin 2159
100 Cards, Mahogany Finish or Oak Cabinet, and Index Dividers. A Useful Accessory to Any Set. Give Name of Set and Sketch of Dial Arrangement. Postpaid on Receipt of Cash or Money Order. Dealers Write for Terms.
S. T. ASTON & SON
114 WORTH STREET NEW YORK CITY

Use the **Bruno** 99 Junior Coil
Price \$5.50
For Hayden's Portable Receiver
Complete parts as prescribed by author **\$13.95**
Write in for Free Catalogues or Hookups
B-C-L Radio Service Co.
220 Fulton St., N. Y. C.

CRAM'S INTERNATIONAL RADIO ATLAS
This latest and greatest Radio Atlas has four big maps, a list of all the Radio Stations in the United States, Canada and the entire world, alphabetically arranged by states and cities, latest wavelengths, kilocycles, and names of operators. Liberal space for your private log. Post paid on receipt of 50c, or one sent free with new yearly subscription for Radio World (\$6.00 for 52 nos.), but with no other premium.
THE COLUMBIA PRINT
1493 Broadway New York City

Over 130 standard radio parts, each bearing the Federal iron-clad performance guarantee.
Federal Standard RADIO Products
Write for Catalog
Federal Telephone & Telegraph Co.
Buffalo, N. Y.

FAHNESTOCK CLIPS
"Popular Wherever Radio Is Used"
14 Sizes in Beautiful Display Case
Dealers, write for big money-making proposition.
FAHNESTOCK ELECTRIC CO.
Long Island City, L. I.

WANTED IN EVERY LOCALITY
An agent to sell Biltmore Master Reflex Receivers to dealers, on our plan which allows the dealer to make summer profits equal winter profits.
The receiver with the "Guaranteed Best Tone"
BILTMORE RADIO COMPANY
Boston 30, Mass. Dept. R.W. 94 Green St.

KICK OUT STATIC
with Welty's De Luxe Crystector
Fits any Neutrodyne or Radio Frequency set—in place of detector tube. Easily attached. No change in wiring. Makes surprising clearness and purity of tone. Practically eliminates static. Reduces battery consumption. Money back if Crystector does not improve your set. Price, \$4.00 prepaid. Agents and dealers, write for offer.
WM. A. WELTY & COMPANY
36 S. State Street Chicago

Radio and Other Technical Books You Need
Radio Telegraph and Telephone Receivers for Beginners \$.75
Design Data for Radio Transmitters and Receivers—M. B. Sleeper75
Wireless in the Home—De Forest15
Commercial Type Radio Apparatus—M. B. Sleeper75
A B C of Vacuum Tubes—Lewis 1.00
Operation of Wireless Telegraph Apparatus35
Lessons in Wireless Telegraphy35
Radio Hookups—M. B. Sleeper75
Construction of New Type Trans-Atlantic Receiving Sets—M. B. Sleeper75
1922 Consolidated Call Book50
How to Make a Standard C W Set35
Any book sent on receipt of price. Postpaid. 20% discount on any two books of same title. The whole list of 11 books sent for
\$6.45
THE COLUMBIA PRINT
1493 Broadway, New York City

TEAR OFF AND MAIL TODAY
8 Weeks' Trial Subscription, \$1.00
KEEP ABREAST OF THE LATEST RADIO DEVELOPMENTS
RADIO WORLD
1493 BROADWAY NEW YORK CITY

at present extends as low as 200 meters and there is talk of increasing it even further downward, as low as 150 meters. The 150 to 200 meter band is at present occupied by amateurs but it is believed they would cheerfully make a sacrifice which will tend to promote the art, acquiring other waves for themselves.

But until there are sets which will tune in stations below 225 meters it is useless for the Departments to assign these wavelengths to stations. Unless the initiative is taken by manufacturers in producing low-tuning sets, the Department may take some action to compel them to do so. (Copyright 1925 by Stevenson Radio Syndicate.)

The LARGEST RADIO STORES in AMERICA

Hook-ups!
All the latest and best kits in our new **RADIO CATALOG**

FREE

NO other Radio Catalog includes such a complete assortment of the best and latest Knock-Down Kits, Parts and Accessories. You need this book—Write for your FREE copy today!

We Save You Money!
Our business is to buy up manufacturers' and government surplus stocks, jobber and dealer bankrupt stocks—but only brand-new fully guaranteed, nationally advertised apparatus. Our catalogues crammed with bargains.

RADIO CHICAGO SALVAGE STOCK STORES

509 So. State St., CHICAGO, ILL., Dept. R.W.6

THE DIAMOND OF THE AIR AS A 2-CONTROL SET, by Herman Bernard. This is the circuit that is sweeping the country. Four tubes; loop or aerial. Send 30c for May 23 and 30 issues of RADIO WORLD, 1493 Broadway, New York City.

THE BABY PORTABLE, by Herbert E. Hayden. A 1-tube DX set on a 7½x5½" panel. Send 30c for May 16 and 23 issues to RADIO WORLD, 1493 Broadway, New York City.

New York and Chicago Tied; Each Has 9 Big Stations

WASHINGTON

NEW York City and Chicago are tied for the honor of having the largest number of powerful broadcasting stations, or stations with power of 500 watts or more. Each of these cities has nine such stations, while Los Angeles comes second with six. After Los Angeles are Philadelphia with five, Seattle, Detroit and Pittsburgh with four each, and Cincinnati with three.

Of the nine New York stations, WEAJ uses 2,500 watts, three 1,000 watts and five 500 watts. One of the Chicago stations uses 1,500 watts, two 1,000 watts and six 500 watts. One of the Los Angeles stations uses 2,000 watts, one 750 and four 500. All five of the Philadelphia stations use 500 watts each. Two of the Seattle stations use 1,000 watts while one has 750 and the other 500. All four of the Detroit stations use 500 watts. One of the Pittsburgh stations uses 1,000 watts, while three have 500. Two of the Cincinnati stations use 5,000 watts each while the other uses 750.

the magnetic field of the coil. Any such metal mass will absorb energy from the inductance through eddy currents and will increase the apparent resistance. Removing all such metallic substances minimizes this resistance. Very often metallic parts which are at a different radio-frequency voltage than the coil and which are unknowingly statically coupled to the inductance will constitute a capacity and increase the resistance.

ABSORPTION CAUSES RESISTANCE

INDUCTANCE when acting as a resistance also has a form of apparent resistance and this is due to the magnetic linkage of the inductance, which absorbs energy from it. The remedy for this form of resistance is obviously to reduce this coupling effect with the exterior coil or coils.

There is still another form of apparent resistance which is also very serious. This is due to the metal substances within

Charted Matched

Bring Your Super Up To Date

—with a set of Silver-Marshall Two-Ten (Inter-stage) and Two-Eleven (Filter) Transformers and a Silver Oscillator Coupler. Regardless of your super's previous efficiency, you can increase its amplification and general efficiency 1½ to 2½ times with this remarkable equipment! Each transformer is supplied with its characteristic curve on a tag. Set of matched and charted transformers and oscillator—Price..... **\$26.50**

Plans for the "Silver-Super"

are now available. This is the set described in last week's "Radio World." Designed by McMurdo Silver, Assoc. I.R.E. Complete working blueprints, baseboard layout, wiring plans, etc..... **50c**

Silver-Marshall, Inc.
112 S. WABASH AVENUE, CHICAGO

Free Mailing Lists

Will help you increase sales. Send for FREE catalog giving counts and prices on classified names of your best prospective customers—National, State, Local—Individuals, Professions, Business Firms.

99% Guaranteed by refund of 5¢ each

ROSS-Gould Co. 315 N. 10th St. St. Louis

EASILY-MADE CRYSTAL SETS. Send 15c for May 16 issue, RADIO WORLD.

RADIO WORLD'S QUICK-ACTION CLASSIFIED ADS.

10 CENTS A WORD. 10 WORDS MINIMUM

DINING AND SLEEPING CAR CONDUCTORS (White). Exp. unnecessary. We train you. Send for book of Rules and application. Supt. Railway Exchange, Sta. C, Los Angeles.

AGENTS—WRITE FOR FREE SAMPLES. Sell Madison "Better-Made" Shirts for large Manufacturer direct to wearer. No capital or experience required. Many earn \$100 weekly and bonus. Madison Mfrs., 501 Broadway, New York.

AMAZING SUMMER RECEPTION! "Radio for Everybody" means 100% efficiency from your set. Handbook—Working Guide—Authority. 360 Pages. 5x8. Profusely illustrated. Just published! Only \$1.65 postpaid. (C. O. D. if desired.) Satisfaction or refund. Mail only. Inventors Library, Dept. 5-A, 417 West 21st St., New York.

A DX TRANSMITTER, by C. H. West, May 23 issue, RADIO WORLD, 15c.

A SIMPLE 1-TUBE DX SET FOR THE NOVICE, by Percy Warren. Send 15c for May 23 issue, RADIO WORLD.

EASILY-MADE CRYSTAL SETS. Send 15c for May 16 issue, RADIO WORLD.

A 3-TUBE REFLEXED NEUTRODYNE, by Percy Warren. Send 15c for May 16 issue, RADIO WORLD.

A SET FOR REDUCING STATIC with diagrams; in RADIO WORLD, dated May 9, 15c. per copy, or start your subscription with that number. RADIO WORLD, 1493 Broadway, New York City.

INEXPENSIVE AND EFFICIENT single tube power amplifier; circuit with instruction, \$1.00. W. G. Conger, Independence, Missouri.

RADIO HOSPITAL: Specialists in Neutrodyne and Super-Heterodynes. Dept. 4, Abilene, Kansas.

SUMMER STATIC CRUSHED. For \$3.00 I will mail specifications for powerful 40 to 600 meter four-tube DX broadcast receiver of extreme selectivity. Easy when you know how. W. G. Conger, Independence, Missouri.

A PUSH-PULL AF AMPLIFIER with diagrams, in RADIO WORLD dated May 9. 15c per copy, or start your subscription with that number. RADIO WORLD, 1493 Broadway, N. Y. C.

A 3-TUBE REFLEXED NEUTRODYNE, by Percy Warren. Send 15c for May 16 issue, RADIO WORLD.

THE BLUEBIRD REFLEX 2-tube earphone marvel by Capt. Peter V. O'Rourke. Send 15c for February 7 issue. RADIO WORLD, 1493 Broadway, New York City.

GETTING BETTER QUALITY FROM AUDIO, by Brewster Lee. Last AF stage connected to two tubes in parallel. Send 15c for May 16 issue to RADIO WORLD, 1493 Broadway, New York City.

THE BABY PORTABLE, by Herbert E. Hayden. A 1-tube DX set on a 7½x5½" panel. Send 30c for May 16 and 23 issues to RADIO WORLD, 1493 Broadway, New York City.

A POWERFUL 3-TUBE REFLEX, by H. E. Wright. Send 15c for May 23 issue, RADIO WORLD.

2650 MILES DISTANCE with one tube. We send complete understandable instructions with panel layout, picture diagrams, etc., for 25c. Or **BIG BOOKLET FREE, VESCO RADIO CO.**, Box 117-RW, Oakland, California.

MAKE MONEY! RADIO BUSINESS. Write Konkle, 192 Market Street, Newark, N. J.

THE SHORT-WAVE RECEIVER REINARTZ WILL USE IN ARCTIC. Full wiring directions. Send 15c for May 16 issue, RADIO WORLD, 1493 Broadway, New York City.

THE DIAMOND OF THE AIR AS A 2-CONTROL SET, by Herman Bernard. This is the circuit that is sweeping the country. Four tubes; loop or aerial. Send 30c for May 23 and 30 issues of RADIO WORLD, 1493 Broadway, New York City.

GETTING BETTER QUALITY FROM AUDIO, by Brewster Lee. Last AF stage connected to two tubes in parallel. Send 15c for May 16 issue to RADIO WORLD, 1493 Broadway, New York City.

A POWERFUL 3-TUBE REFLEX, by H. E. Wright. Send 15c for May 23 issue, RADIO WORLD.

EASILY-MADE CRYSTAL SETS. Send 15c for May 16 issue, RADIO WORLD.

GETTING BETTER QUALITY FROM AUDIO, by Brewster Lee. Last AF stage connected to two tubes in parallel. Send 15c for May 16 issue to RADIO WORLD, 1493 Broadway, New York City.

NOW you can get it for the first time in America

Used in eighty per cent of all
receiving sets in Great Britain

The "BRETWOOD"

*Pulls in
inaudible
stations*

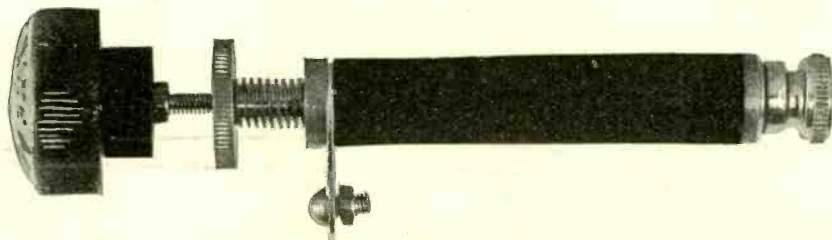

*Eliminates
tube
noises*

Range 300,000 to 10,000,000 ohms

Variable Grid Leak

Bretwood, Ltd., London, Eng., Sole Patentees and Owners.

The Bretwood Variable Grid Leak used in a detector tube circuit, strengthens weak signals, makes DX easier, eliminates tube noises and internal howling, due to incorrect leakage from the grid of the tube.

By simply turning the knob the carrier wave may be tuned from the silent point to maximum audibility.

The Bretwood is absolutely noiseless in operation and will hold any given setting indefinitely. It is a single-hole panel mount leak.

The Bretwood Variable Grid Leak, tested in the National Physical Laboratory (the official laboratory of Great Britain) and by RADIO WORLD'S Laboratory, proved to be a scientifically accurate instrument. The total range, 9,700,000 ohms, produced by 25 turns of the knob, make a minute adjustment very simple.

The Bretwood Variable Grid Leak is constructed on a different principle and produces better results than any other grid leak. In its specially-constructed barrel is a patented plastic, non-drying resistance material, in which there is a small movable plunger which again moves freely in an absorbent cartridge which gives the setting of the instrument great stability, making it far superior to the graphite, carbon or fibre, compressed or decompressed, resistance elements. It can be used in the most critical circuits with the greatest success.

Sent You on a Money Back Absolute Satisfaction Guarantee

The Bretwood Variable Grid Leak will be immediately shipped on receipt of order to any address in the United States, prepaid for \$1.50. After 10 days' trial if it is not 100% better than any grid leak you have ever had and does not in every way substantiate all claims made for it, your money will be refunded without question.

The North American Bretwood Company

*Sole Distributors for
United States and Canada*

1505 BROADWAY, NEW YORK CITY

*Dealers and Jobbers Write for
Special Trade Terms*

THE NORTH AMERICAN BRETWOOD CO.
1505 Broadway, New York City
Room 326

Gentlemen:

Enclosed find \$1.50 for which you will please send me one Bretwood Variable Grid Leak prepaid. Satisfaction guaranteed or my money back after trial within ten days of receipt by me.

NAME

STREET

CITY STATE